



Battery Module User Manual

Product name: 2U wall-mounted-battery module

POWER WALL A5120x2

(Certificate Model: YNJB16S100KX-L-2PP)

Version: P1.0

This manual describes the instructions for using the 2U wall-mounted-battery module (POWER WALL A5120x2). Please read this manual before installing the batteries and follow the instructions carefully during installation. If there is any confusion, please contact the manufacturer immediately for advice and clarification.

Catalogue

Chapter 1 Products	3
Chapter 2 Battery Module Safe Handling Guide	8
Chapter 3 Product Installation Instructions	10
Chapter 4 Safety Precautions	14
Chapter 5 Troubleshooting	15
Chapter 6 Emergencies	16

Chapter 1 Products

The 2U wall-mounted-battery module (POWER WALL A5120x2) is one of the new energy storage products that can be used to support reliable power for various devices and systems. It is especially suitable for high power, limited installation space, restricted load bearing and long cycle life application scenarios. POWER WALL A5120x2 has a built-in BMS battery management system that manages and monitors battery information including voltage, current and temperature. In addition, the BMS can balance the charge and discharge of the battery to extend the cycle life. Multiple batteries can be connected in parallel to expand capacity and power paralleling for greater capacity and longer power support time requirements.

1.1. Characteristic introduction

- Battery module using lithium iron phosphate cells, compared with the same size lead-acid battery weight reduced by 40%;
- Exterior wall-mounted structure, which allows the module to be wall-mounted, easy and flexible to maintain, and highly versatile;
- Battery module housing with insulated painted metal sheet metal;
- High-power quick-plug connector for the power output input of the battery module, supporting hot-swapping;
- Battery modules can support up to 7 groups for parallel use, not for series use
- Low self-discharge of the battery module, no memory effect, more excellent performance of shallow charging and discharging;

1.2. Function Introduction

- ✓ ARM low-power processors;
- ✓ Use of professional battery management chips;
- ✓ Support for current-limited charging mode (up to 20A);
- ✓ Support for CAN/RS485 communication;
- ✓ Built-in 4-channel temperature acquisition;
- ✓ Support high and low temperature overcharge and overdischarge protection;
- ✓ Support for battery equalization functions;

- ✓ Support for SOC calculation and calibration;
- ✓ Support two levels of overcurrent protection;
- ✓ Support for output short-circuit protection;
- ✓ Support for reverse polarity protection;
- ✓ Support for data storage;
- ✓ Multiple automatic fault detection (sampling, MOS, battery failure)

1.3. Specification parameters



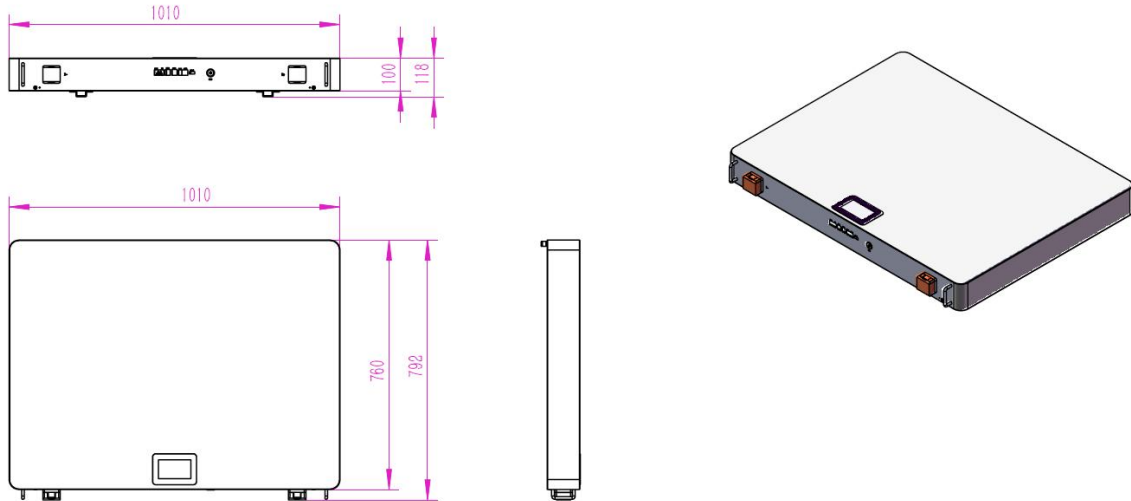

Battery module size diagram

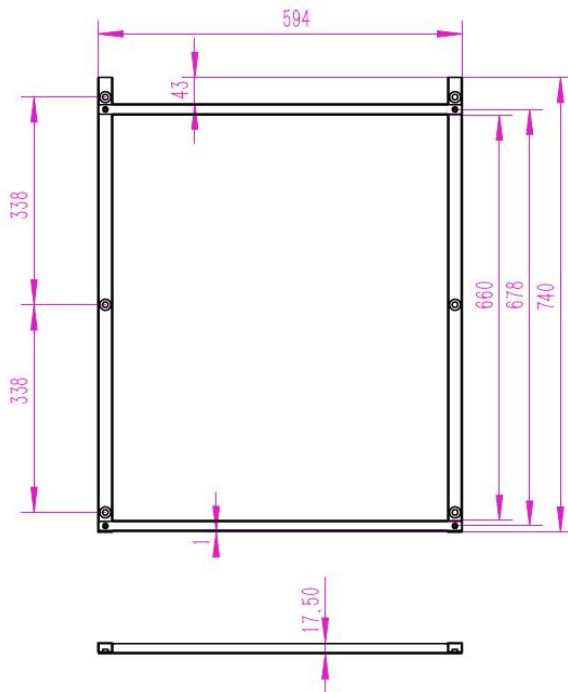

Mounting bracket size drawing

Product Model	POWER WALL A5120x2
Battery voltage rating	51.2V
Operating voltage range	44.8V to 57.6V
Support floating charge voltage	55V±1V
Battery Capacity	200Ah
Battery power	10.24KWh
Internal resistance	≤50mΩ
Rated discharge current/maximum allowable discharge current	100A/200A
Rated charging current/maximum allowable charging current	100A/200A
Battery operating ambient temperature range	Charge 0°C ~ +56°C Discharge -20°C ~ +56°C

Recommended working environment temperature	+10℃~+30℃
Storage temperature specification	0-25℃/12 months
Battery module size (W*D*H mm)	Bare machine: 1010*792*100mm (case)
Weight	93±0.5KG
Housing	Metal housing with insulation coating
Cooling method	Natural cooling
Display method	Display
Communication method	External: CAN/RS485 Internal: RS485 PC upper computer: RS232

1.4. Interface Definition

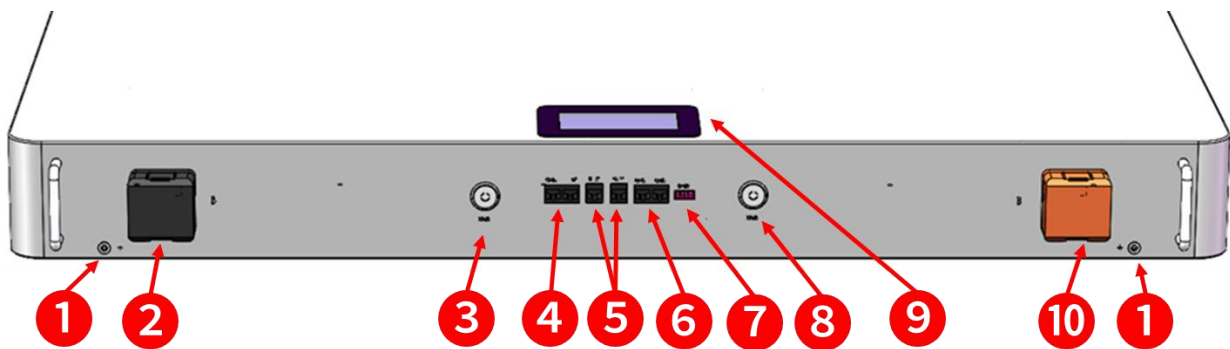

❶	Ground wire hole	❸	RS485 interface
❷	Load Negative	❹	Dry Node
❸	Host power switch	❺	Slave power switch
❹	RS485/CAN interface	❻	Screen
❺	RS232 interface	❼	Load Positive

Ground wire hole

Ground hole: Equipment grounding.

Load terminal (B+/B-)

Power terminals: Two pairs of terminals of the same function are used with cold-pressure terminal blocks RNB22-8, one connected to the device and the other connected in parallel to other battery modules for capacity increase. For each single module, each terminal can perform charging and discharging functions.

Dry Node

Dry node: Dry contact 1-PIN1 to PIN2: Normally open, low battery closed.
Dry contact 2-PIN3 to PIN4: Normally open, closed in case of fault or protection.

Power Switch

Power switch: turns on/off the entire battery pack status.

Screen

Display: Display the parameters of the battery module.

(1) Main menu page

After power-up/sleep activation, the BMS internal data will be displayed, as shown below:

To skip to the next page just click on the margin.

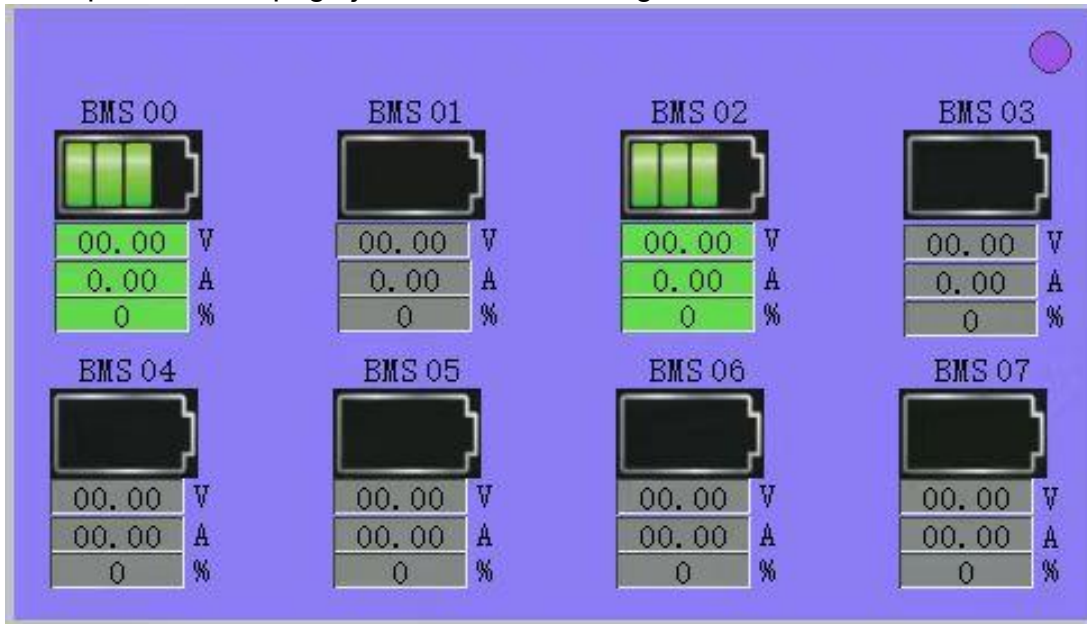

(2) Battery parameter acquisition page

After clicking on the BMS, it will enter the "Battery Parameter Acquisition" page, as shown in the following figure:

If you need to go back, just press the margin.

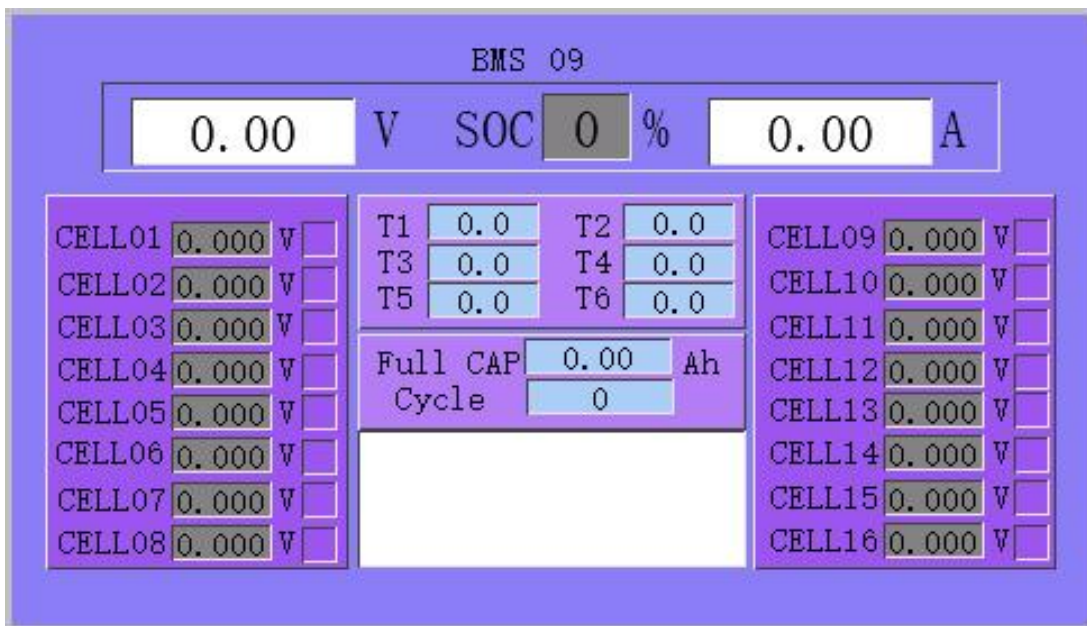

RS485/CAN interface

RS485/CAN communication interface: (RJ45 port) Communication according to

RS485/CAN protocol.

RS485 - using 8P8C vertical RJ45 socket		CAN - using 8P8C vertical RJ45 socket	
RJ45 Pinout	Definition Description	RJ45 Pinout	Definition Description
9, 16	RS485-B1	1, 2, 3, 6, 8	NC
10, 15	RS485-A1	4	CANH
11, 14	GND	5	CANL
12, 13	NC	7	GND

RS485/CAN interface definition

RS232 interface

RS232 communication interface: (RJ11 port) Communication according to RS232 protocol, you can view the battery output information.

RS232 - using 8P8C vertical RJ45 socket	
RJ11 Pins	Definition Description
2	NC
3	Sending data
4	Accepted data
5	GND

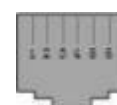

RS232 interface definition

RS485 interface

RS485 communication interface: (RJ45 port) communicate according to RS485 protocol, read battery information, also can be used for multiple groups of lithium batteries for parallel communication.

RS485 - using 8P8C vertical RJ45 socket		RS485 - using 8P8C vertical RJ45 socket	
RJ45 Pinout	Definition Description	RJ45 Pinout	Definition Description
1, 8	RS485-B1	9, 16	RS485-B1
2, 7	RS485-A1	10, 15	RS485-A1
3, 6	GND	11, 14	GND
4, 5	NC	12, 13	NC

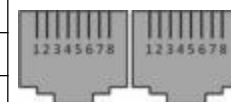

RS485 parallel communication interface definition

BMS Functionality

Protection and alarms	Management and monitoring
End of charge/discharge	Battery Balance
Charging overvoltage	Smart charging mode
Charge/discharge overcurrent	Charging current limit
High/low temperature	Calculation of capacity reservation
Short Circuit	Administrator Monitoring
Reverse power cord connection	Operation log

Chapter 2 Battery Module Safe Handling Guide

2.1. System topology diagram

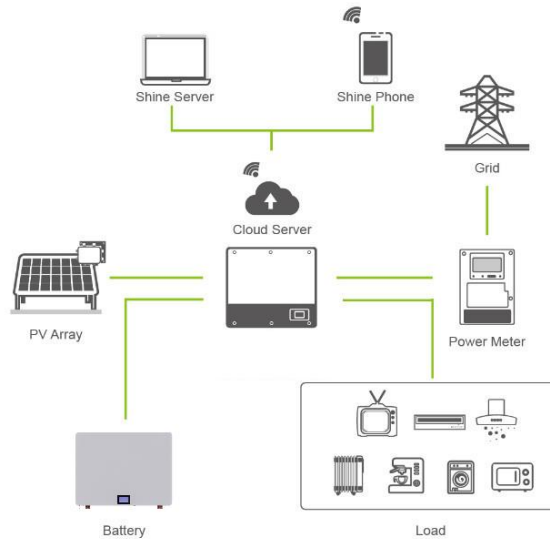

2.2. Marking

Lithium Battery Module		⚠ DANGER HIGH VOLTAGE INSIDE	
<p>Model: YNJB16S100KX-L-2PP</p> <p>Nominal Voltage: 51.2V</p> <p>Charge Voltage: 57.6V</p> <p>Cut Off Voltage: 44.8V</p> <p>Nominal Capacity: 200Ah/10.24KWh</p>			<p>*Do not disconnect, disassemble or repair by yourself.</p> <p>*Do not drop, deform, impact, cut or spearing with a sharp object.</p> <p>*Do not place near open flame or incinerate.</p> <p>*Do not sit or put heavy things on battery.</p> <p>*Keep away from moisture or liquid.</p> <p>*Keep out of reach of children, animals or insects.</p> <p>Emergency Situations</p> <p>*If leaking, fire, wet or damaged, switch off the breaker and go away from the battery.</p> <p>*Do not touch the leaking liquid. Do not use water. Sand or dry power extinguisher is usable.</p>
<p>YNJ16KX2DF00000000</p>			

2.3. Tools

To install the battery pack, you may need these tools:



Phillips screwdriver

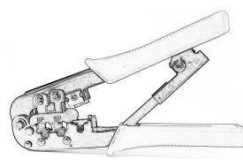

Cable Crimper

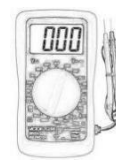

Voltmeter

NOTE: Use a properly insulated tool to prevent accidental electric shock or short circuit. If insulated tools are not available, cover the entire exposed metal surface of the available tools, except their tips, with insulating tape.

2.4. Security

It is recommended that the following safety equipment be worn when handling battery packs



Insulation gloves



Goggles



Safety shoes

2.5. Attachment List

Name	Specification	Quantity
Expansion screws	M8*60mm	6
Connector screws	M8*10mm	4
Ground Screw	M5*10mm	2
Snap Pendant	N/A	2
Pan head screws	M6*20	4
Wall-mounted racks	594*740mm	1
User manual	POWER WALL A5120x2	1
Packing list	POWER WALL A5120x2	1
Warranty Card	POWER WALL A5120x2	1

Chapter 3 Product Installation Instructions

3.1. Connection Instructions

Note: For safe operation and regulatory compliance, a separate DC overcurrent protector or disconnect device is required for battery installation. In some applications, a disconnect device may not be required, but an overcurrent protection device is still required. Refer to the table below for typical amperage for the required fuse or breaker size.

Warning! All wiring must be done by qualified personnel.

Warning! Using the proper cables for battery connections is important for safe and efficient system operation. To reduce the risk of injury, use the appropriate recommended cable and terminal sizes below.

Recommended battery cable and terminal sizes.

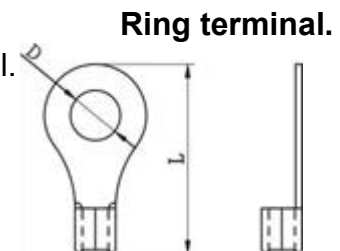

Battery Capacity	Cable Size	Ring terminals		
		Cable mm ²	Size	
			D (mm)	L(mm)
200Ah	2AWG	33	8.4	33.5

3.2. Installation conditions

Please ensure that the installation location meets the following conditions:

- The area is completely waterproof.
- The floor is flat.
- No flammable and explosive materials.
- The ambient temperature is within the range of 0°C to 50°C.
- Temperature and humidity are maintained at a stable level.
- There is very little dust and dirt in the area.

3.3. Installation Instructions

Caution



If the ambient temperature is outside the operating range, the battery pack will stop working to protect itself. The optimal temperature range for battery pack operation is 0°C to 50°C. Frequent exposure to harsh temperatures may degrade the performance and life of the battery pack.

A. Wall-mounted installation

1. Set 6 points on the wall and use $\phi 10 \times 90$ impact drill for drilling operation
2. M8 * 60 expansion screws into the drilled holes
3. Place the wall-mounted rack on the M8*60 expansion screw and fix it
4. The wall-mounted battery module on the snap pendant and the slot with the snap can be
5. Connect the ground cable of the battery module
6. Communication cable for connecting battery module
7. Connect the cable to the inverter

Set up 6 points on the wall and use $\phi 10 \times 90$ impact drill to make holes.

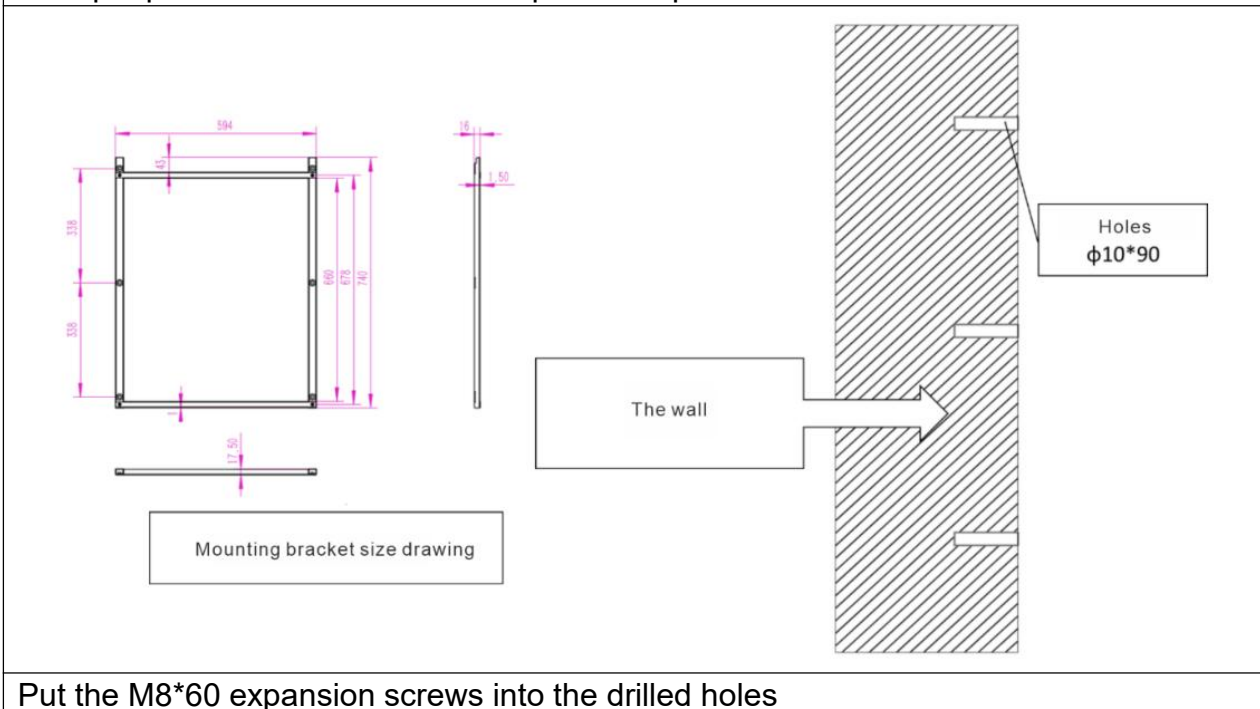

Put the M8*60 expansion screws into the drilled holes

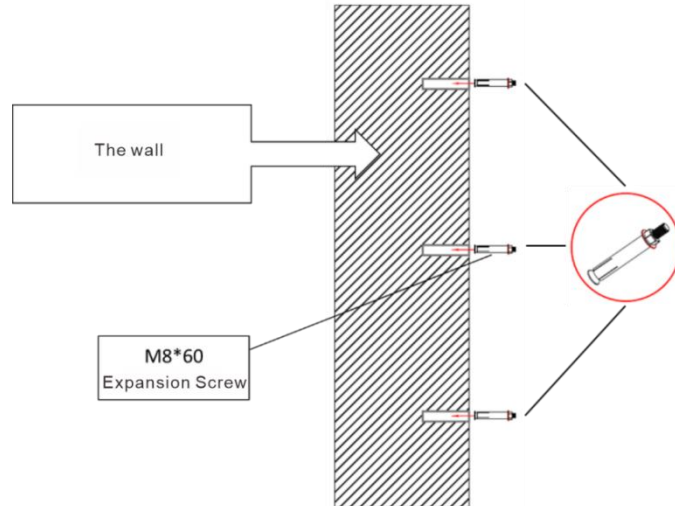

Place the wall-mounted rack on the M8*60 expansion screw and fix it

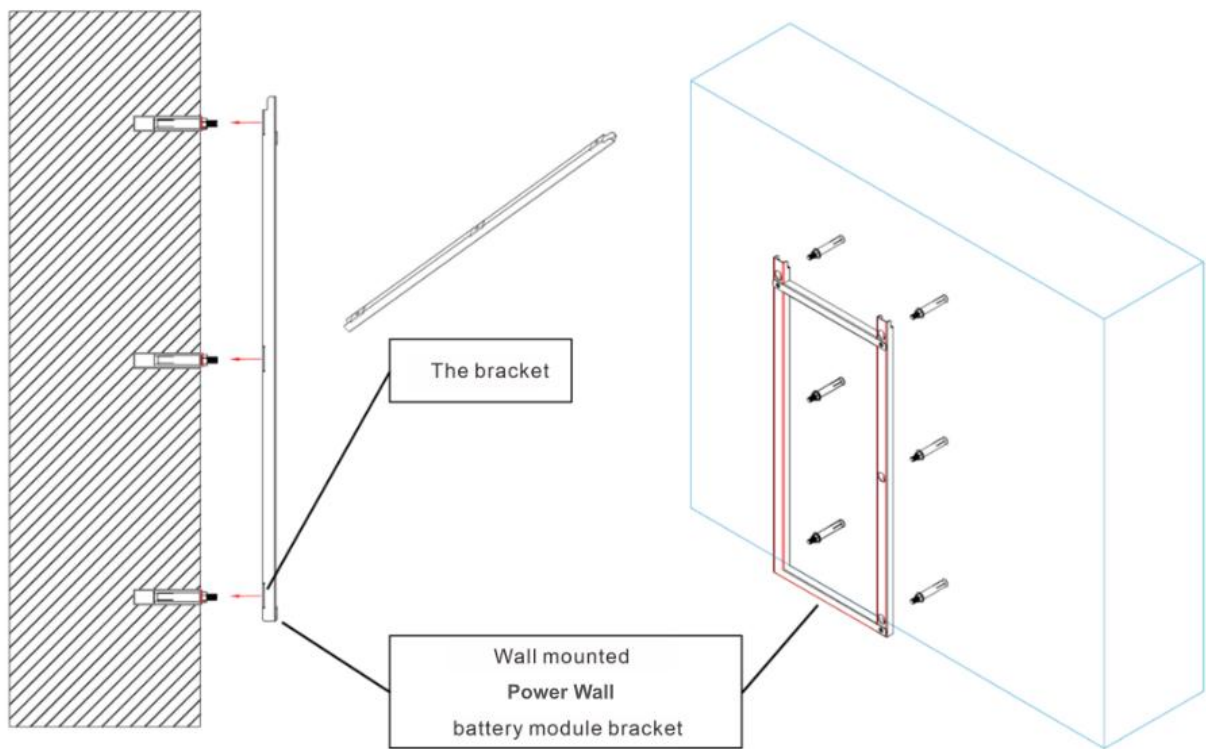

The snap pendant on the wall-mounted battery module can be hooked to the slot with the snap

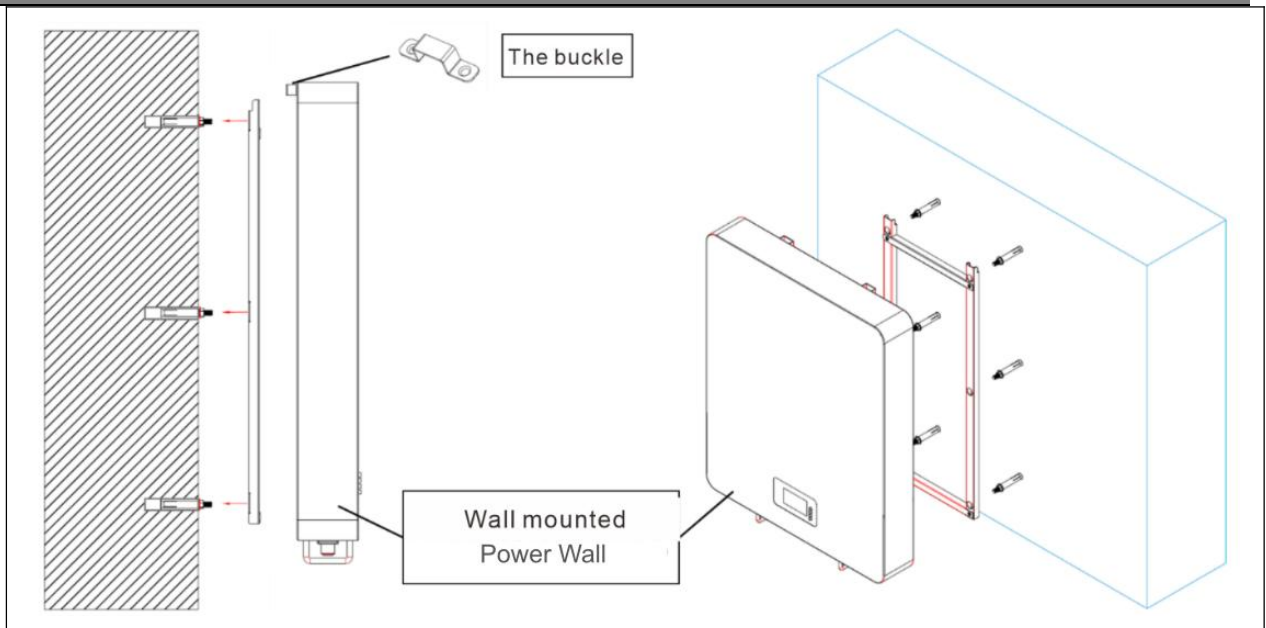

B. Parallel installation

1. Set 6 points on the wall and use $\phi 10 \times 90$ impact drill for drilling operation
2. M8 * 60 expansion screws into the drilled holes
3. Place the wall-mounted rack on the M8*60 expansion screw and fix it
4. The wall-mounted battery module on the snap pendant and the slot with the snap can be
5. Connect the ground cable between the battery modules
6. Connect the communication cable between the battery modules
7. Connect the cables between the battery modules
8. Connect the cable to the inverter

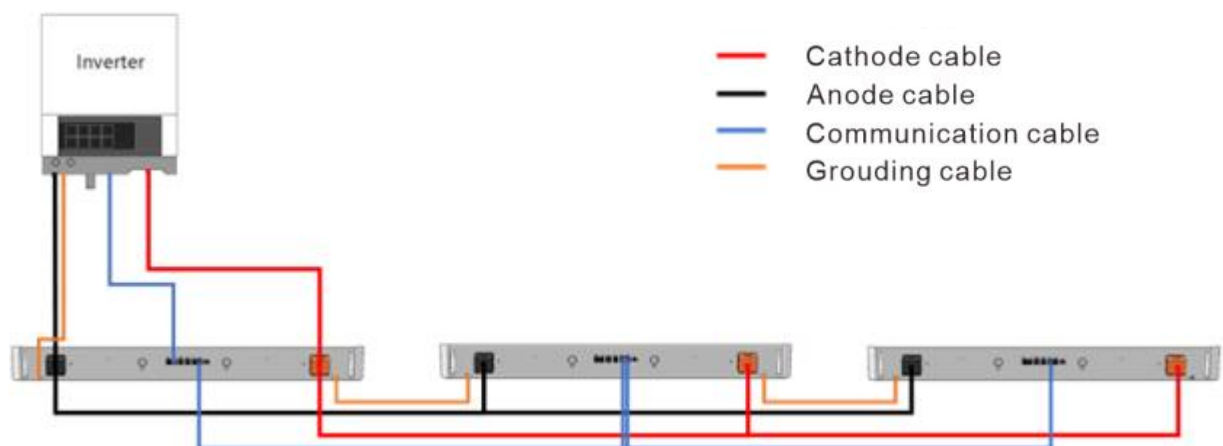

3.4. Power on instructions

- (1) Turn on the power

Double-check all power and communication cables.

Turn on all battery modules and make sure the display dot is on.

- (2) Parallel mode connection

Normal parallel mode, as shown in the following figure

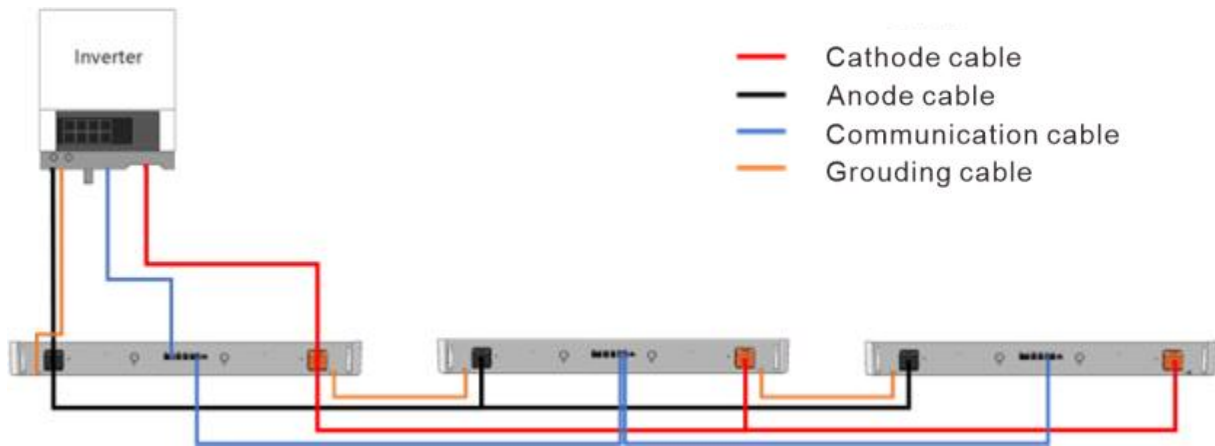

Note: If all battery displays are on, this means that the battery system is good and working properly.

Chapter 4 Safety Precautions

Warning

4.1. Precautions before installation

- 1) After opening the box, please check the product and packing list first, if the product is damaged or missing parts, please contact your local retailer;
- (2) Before installation, be sure to cut off the power to the grid and ensure that the battery is in the off state;
- 3) Wiring must be correct, do not make mistakes with positive and negative cables, and ensure that there is no short circuit with external equipment;
- (4) prohibit the direct connection of batteries and AC power;
- 5) the embedded BMS in the battery is designed for 48VDC, please do not connect the battery in series;
- 6) the battery system must be well grounded and its resistance must be less than 1Ω;
- 7) Please ensure that the electrical parameters of the battery system are compatible with the relevant equipment;
- 8) Keep the battery away from water and fire.

4.2. Precautions for the use process

- 1) If the battery system needs to be moved or repaired, the power must be disconnected and the battery completely shut down;
- 2) It is strictly forbidden to connect the battery with different types of batteries.
- 3) It is strictly forbidden to work the battery with faulty or incompatible inverters;
- 4) Battery disassembly is strictly prohibited (QC tags are removed or damaged);
- 5) In the event of a fire, only dry powder fire extinguishers may be used, and the use of liquid fire extinguishers is prohibited;
- 6) Do not open, repair or disassemble the battery except by personnel authorized by the manufacturer or distributor. We assume no responsibility for any consequences or liability associated with violations of safe practices or violations of design, manufacturing and equipment safety standards.

Reminder

- 1) Please read the user manual (in the attachment) carefully;
- (2) If the battery is stored for a long time, it needs to be charged every six months, and the SOC should be no less than 80%;
- 3) The battery needs to be recharged within 12 hours after it has been completely discharged;
- 4) Do not expose cables to the elements;
- 5) All battery terminals must be disconnected for maintenance purposes;
- 6) If there is any abnormality, please contact the supplier within 24 hours.
- 7) Direct or indirect damages caused by the above items are not covered by the warranty.

Chapter 5 Troubleshooting

5.1. Troubleshooting steps

- 1) Whether the battery can be turned on;
- 2) If the battery is on, check that the red light is off, flashing or on;
- 3) If the red light is off, check if the battery can be charged/discharged.

5.2. Fault Identification

The battery cannot be turned on, and none of the lights light up or flicker after the power is turned on.

If the external battery switch is on, the status light is flashing, the external power supply voltage is 48V or more, and the battery still does not turn on, please contact your dealer.

The battery can be turned on, but the red light is on and cannot be charged or discharged. If the red light is on, the system is not working properly, please check the following values:

Temperature: Above 56°C or below -20°C, the battery cannot work.

Solution: Move the battery to a normal operating temperature range of -10°C to 50°C.

Current: If the current is greater than 200A, the battery protection will open.

Solution: Check if the current is too high, if it is, change the setting on the power side.

High voltage: If the charging voltage exceeds 57.6V, the battery protection will turn on.

Solution: Check if the voltage is too high, if so, change the setting on the power side.

Low Voltage: When the battery is discharged to 44.8V or lower, the battery protection will be turned on. Solution: Charge the battery for a period of time, and the red light will turn off.

In addition to the above four points, if you still can not find the fault, please turn off the battery and repair.

5.3. Charging Troubleshooting

- 1) Cannot be charged:

Disconnect the power cord, measure the voltage on the power side, if the voltage is 53~54V, restart the battery, connect the power cord and try again, if it still doesn't work, turn off the battery and contact the dealer.

- 2) Unable to discharge:

Disconnect the power cord and measure the voltage on the battery side, if it is lower than 44.8V, please charge the battery; if the voltage is higher than 48V and still cannot be discharged, please turn off the battery and contact your dealer.

Chapter 6 Emergencies

6.1. Battery leakage

If the battery pack leaks electrolyte, avoid contact with the leaking liquid or gas. In case of contact with the leaking substance, the following measures should be taken immediately.

Inhalation: Evacuate the contaminated area and seek medical attention.

Contact with eyes: Flush eyes with running water for 15 minutes and seek medical attention. Contact with skin: Wash affected area thoroughly with soap and water and seek medical attention.

Ingestion: Induce vomiting and seek medical attention.

6.2. Fire

Do not use water! Use only dry powder extinguishers; if possible, move the battery pack to a safe area before it catches fire.

6.3. Immersion

If the battery pack gets wet or submerged in water, do not let anyone touch it, then contact the manufacturer or an authorized distributor for technical support.

6.4. Battery damage

Damaged batteries are dangerous and must be handled with the utmost care. They are unfit for use and may pose a danger to persons or property. If a battery pack appears to be damaged, pack it in its original container and return it to the manufacturer or authorized distributor.