



# **USER MANUAL**

## **N3H-X Series Hybrid Inverter**

**CONTENTS**

**1. NOTES ON THIS MANUAL** ..... 3

    1.1 SCOPE OF VALIDITY ..... 3

    1.2 TARGET GROUP ..... 3

    1.3 SYMBOLS USED ..... 3

**2. SAFETY** ..... 4

    2.1 IMPORTANT SAFETY INSTRUCTIONS ..... 4

    2.2 EXPLANATION OF SYMBOL ..... 8

**3. INTRODUCTION** ..... 9

    3.1 BASIC FEATURES ..... 9

    3.2 SYSTEM DIAGRAM ..... 9

    3.3 WORK MODES ..... 12

    3.4 DIMENSION ..... 13

    3.5 TERMINALS OF PV INVERTER ..... 14

**4. TECHNICAL PARAMETERS** ..... 16

    4.1 INVERTER SPECIFICATION ..... 16

**5. INSTALLATION** ..... 18

    5.1 CHECK FOR PHYSICAL DAMAGE ..... 18

    5.2 PACKING LIST ..... 18

    5.3 MOUNTING ..... 19

**6. ELECTRICAL CONNECTION** ..... 22

    6.1 PV CONNECTION ..... 22

    6.2 GRID CONNECTION (GEN CONNECTION) ..... 23

    6.3 BACK-UP: LOAD CONNECTION ..... 24

    6.4 BATTERY CONNECTION ..... 26

    6.5 WI-FI CONNECTION ..... 27

    6.6 CT INSTALLATION INSTRUCTIONS ..... 28

    6.7 RSD (ON/OFF) INSTALLATION ..... 29

**7. LED OPERATION** ..... 31

    7.1 CONTROL PANEL ..... 31

    7.2 WORKING STATUS ..... 33

    7.3 SETTING ..... 36

**8. GENERATOR USE OPERATION GUIDE** ..... 46

    8.1 GENERATOR USE DIAGRAM ..... 46

    8.2 GENERATOR OPERATION NOTES ..... 47

    8.3 GENERATOR SETTING ..... 48

**9. INVERTER PARALLEL GUIDE** ..... 50

    9.1 PARALLEL SYSTEM DIAGRAM ..... 50

9.2 PARALLEL COMMUNICATION CABLE CONNECTION .....	52
9.3 PARALLEL OPERATION NOTES .....	52
9.4 PARALLEL SYSTEM SETTING .....	53
<b>10. ADVANCED MODE OPERATION GUIDE .....</b>	<b>55</b>
10.1 ADVANCED MODE INTRODUCTION .....	55
<b>11. FAULT DIAGNOSIS AND SOLUTIONS .....</b>	<b>58</b>

NOTE: Due to the limited display area on the screen, the corresponding nouns will be abbreviated and the relevant explain will be displayed in the article.

# 1. Notes on this Manual

## 1.1 Scope of Validity

This manual is an integral part of Hybrid, it describes the assembly, installation, commissioning, maintenance, and failure type of the product. Please read it carefully before operating.

N3H-X5US	N3H-X8US	N3H-X10US
----------	----------	-----------

Naming rules, For example: N3H-X8US

“H” means “Hybrid”

“8” means “output power 8kw”.

“N”“US” means “for North America and United States market”

Store this manual where it will be accessible at all times.

## 1.2 Target Group

This manual is for qualified electricians. The tasks described in this manual only can be performed by qualified electricians.

## 1.3 Symbols Used

The following types of safety instructions and general information appear in this document as described below:

	<p><b>Danger!</b></p> <p>“Danger” indicates a hazardous situation which, if not avoided, will result in death or serious injury.</p>
---	--

	<p><b>Warning!</b></p> <p>“Warning” indicates a hazardous situation which, if not avoided, could result in death or serious injury.</p>
---	---

	<p><b>Caution!</b></p> <p>“Caution” indicates a hazardous situation which, if not avoided, could result in minor or moderate injury.</p>
---	--

	<p><b>Note!</b></p> <p>“Note” provides tips that are valuable for the optimal operation of ours.</p>
---	--

## 2. Safety

### 2.1 Important Safety Instructions



**Danger!**

- Danger to life due to high voltages in the inverter!
- All work must be carried out by qualified electrician.
- The appliance is not to be used by children or persons with reduced physical sensory or mental capabilities, or lack of experience and knowledge, unless they have been given supervision or instruction.
- Children should be supervised to ensure that they do not play with the appliance.



**Caution!**

- Danger of burn injuries due to hot enclosure parts!
- During operation, the upper lid of the enclosure and the enclosure body may become hot.
- Only touch the lower enclosure lid during operation.



**Caution!**

- Possible damage to health as a result of the effects of radiation!
- Do not stay closer than 20 cm to inverter for any length of time.



**Note!**

- Grounding the PV generator.
- Comply with the local requirements for grounding the PV modules and the PV generator. It is recommended connecting the generator frame and other electrically conductive surfaces in a manner which ensures continuous conduction and ground these in order to have optimal protection of system and persons.



**Warning!**

- Ensure input DC voltage  $\leq$  Max. DC voltage. Over voltage may cause damage.
- Permanent damage to inverter or other losses, which will not be included in warranty!



**Warning!**

- Authorized service personnel must disconnect both AC and DC power from inverter before attempting any maintenance, cleaning or working on any circuits connected to inverter.



**Warning!**

- Do not operate the inverter when the device is running.



**Warning!**

- Risk of electric shock!

- Please keep the user manual properly. When operating equipment, in addition to following the general precautions in this document, follow the specific safety instructions. We will not be liable for any consequence caused by the violation of the safety operation regulations and design, production, and usage standards.
- Only accessories shipped with the inverter are recommended for use, Otherwise, it may result in a risk of fire, electric shock, or injury to person.
- Make sure the existing wiring is in good condition and the wire is not undersized. Do not disassemble any parts of the inverter which are not mentioned in the installation guide. It contains no user-serviceable parts. See Warranty for instructions on obtaining service. Attempting to service the inverter yourself may result in a risk of electric shock or fire and will void your warranty.
- Keep away from flammable, explosive materials to avoid fire disaster.
- The installation place should be away from humid or corrosive substance.
- Authorized service personnel must use insulated tools when installing or working with this equipment.
- Never touch either the positive or negative pole of the PV connecting device. It's strictly prohibited touching both at the same time.
- The unit contains capacitors that remain charged to a potentially lethal voltage after the MAINS, battery and PV supply has been disconnected.

- Hazardous voltage will present for up to 5 minutes after disconnection from power supply.
- CAUTION-RISK of electric shock from energy stored in capacitor, never operate on the inverter couplers, the MAINS cables, Battery cables, PV cables or the PV generator when power is applied. After switching off the PV, battery, and Mains, always wait for 5minutes to let the intermediate circuit capacitors discharge before unplugging DC, battery in plug and MAINS couplers.
- When accessing the internal circuit of inverter, it is very important to wait 5 minutes before operating the power circuit or demounting the electrolyte capacitors inside the device. Do not open the device beforehand since the capacitors require time to sufficiently discharge!
- Surge protection devices (SPDs) for PV installation



**WARNING!**

- Over-voltage protection with surge arresters should be provided when the PV power system is installed.
- The grid connected inverter is not fitted with SPDs in both PV input side and MAINS side.

- Lightning will cause a damage either from a direct strike or from surges due to a nearby strike.
- Induced surges are the most likely cause of lightning damage in majority or installations, especially in rural areas where electricity is usually provided by long overhead lines. Surge may be included on both the PV array conduction and the AC cables leading to the building.
- Specialists in lightning protection should be consulted during the end use application. Using appropriate external lightning protection, the effect of a direct lightning strike into a building can be mitigated in a controlled way, and the lightning current can be discharged into the ground.
- Installation of SPDs to protect the inverter against mechanical damage and excessive stress include a surge arrester in case of a building with external lightning protection system (LPS) when separation distance is kept.
- To protect the DC system, surge suppression device (SPD type2) should be fitted at the inverter end of the DC cabling and at the array located between the inverter and the PV generator, if the voltage protection level (VP) of the

surge arresters is greater than 1100V, an additional SPD type 3 required for surge protection for electrical devices.

- To protect the AC system, surge suppression devices (SPD type2) should be fitted at the main incoming point of AC supply (at the consumers cutout), located between the inverter and the meter/distribution system;
- All DC cables should be installed to provide as short a run as possible, and positive and negative cables of the string or main DC supply should be bundled together. Avoiding the creation of loops in the system.
- Spark gap devices are not suitable to be used in DC circuits once conducting, they won't stop conducting until the voltage across their terminals is typically more than 30 volts.

➤ Anti-Islanding Effect

Islanding effect is a special phenomenon that grid-connected PV system still supply power to the nearby grid when the voltage loss has happened in the power system. It is dangerous for maintenance personnel and the public.

Hybrid series inverter provide Active Frequency Drift (AFD) to prevent islanding effect.

➤ PE Connection and Leakage Current

The end-use application shall monitor the protective conductor by residual current operated protective device (RCD) with rated fault current  $I_{fn} \leq 240\text{mA}$  which automatically disconnects the device in case of a fault.

The device is intended to connect to a PV generator with a capacitance limit of approx. 700nf.



**WARNING!**

- High leakage current!
- Earth connection essential before connecting supply.

Incorrect grounding can cause physical injury, death or equipment malfunction and increase electromagnetic.

➤ Battery Safety Instructions

Hybrid Series inverter should be worked with low voltage battery, for the specific parameters such as battery type, nominal voltage and nominal capacity etc, please refer to section 4.1.

As accumulator batteries may contain potential electric shock and short-circuit current danger, to avoid accidents that might be thus resulted, the following warnings should be observed during battery replacement:













- 1: Do not wear watches, rings or similar metallic items.
- 2: Use insulated tools.
- 3: Put on rubber shoes and gloves.
- 4: Do not place metallic tools and similar metallic parts on the batteries.
- 5: Switch offload connected to the batteries before dismantling battery connection terminals.
- 6: Only personal with proper expertise can carry out the maintenance of accumulator batteries.

## 2.2 Explanation of Symbol

This section gives an explanation of all the symbols shown on the inverter and on the type label.

### Symbols on the Type Label

	<p>UL certified</p>
	<p>This symbol indicates that you should wait at least 5 min after disconnecting the inverter from the utility grid and from the PV panel before touching any inner live parts.</p>
	<p>Keep dry! The package/product must be protected from excessive humidity and must be stored under cover.</p>
	<p>Refer to the operating instructions.</p>
	<p>Fragile - The package/product should be handled carefully and never be tipped over or slung.</p>
	<p>Products should not be disposed as household waste.</p>
	<p>No more than six (6) identical packages being stacked on each other</p>
	<p>Components of the product can be recycled.</p>
	<p>Danger of hot surface!</p>
	<p>Danger of high voltage and electric shock!</p>
	<p>Caution! Failure to observe a warning indicated in this manual may result in injury</p>

### 3. Introduction

#### 3.1 Basic features

Hybrid Series is a high-quality inverter which can convert solar energy to AC energy and store energy into battery.

The inverter can be used to optimize self-consumption, store in the battery for future use or feed into public grid. Work mode depends on PV energy and user’s preference. It can provide power for emergency use during the grid lost by using the energy from battery and inverter (generated from PV).

#### 3.2 System Diagram

Hybrid Series is designed with two BACK-UP versions for customer to choose based on the local rules. This applies to the wiring rules that requires Neutral line of alternative supply must NOT be isolated or switched.

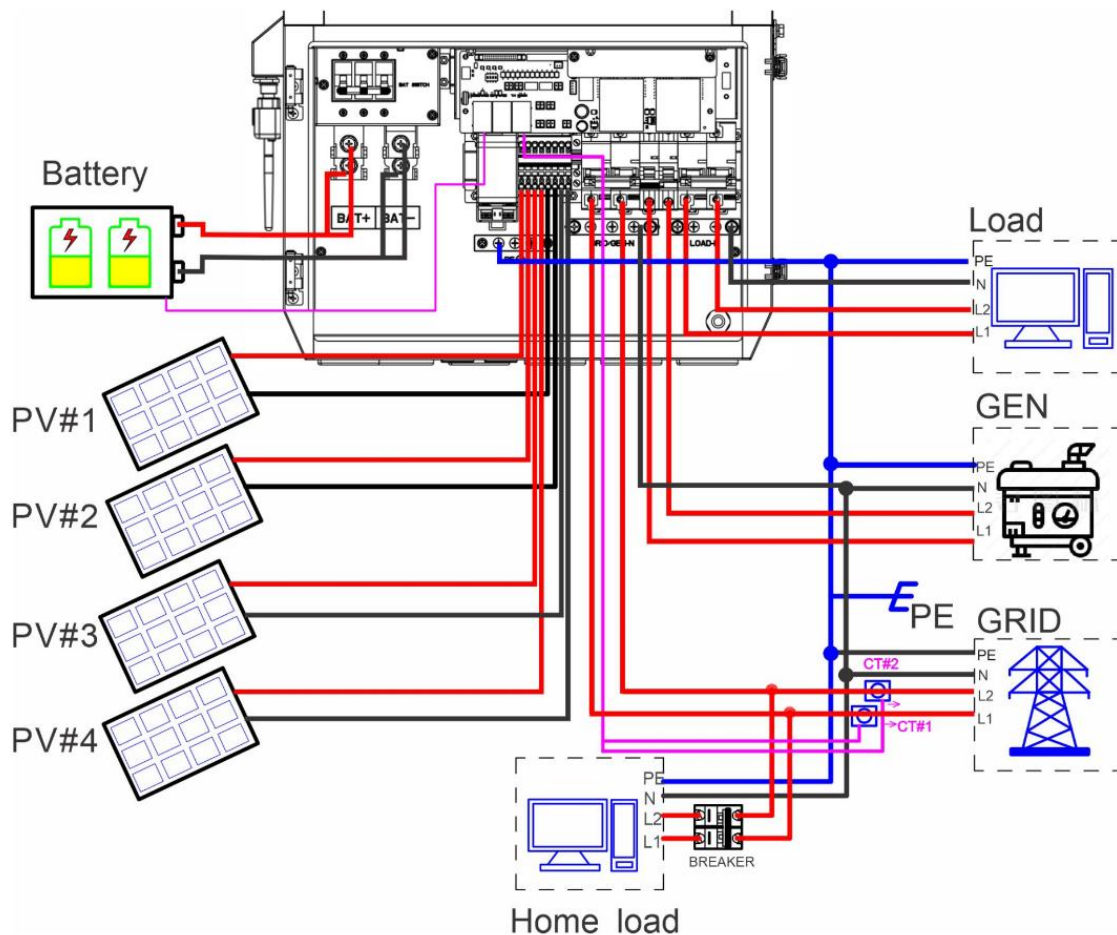

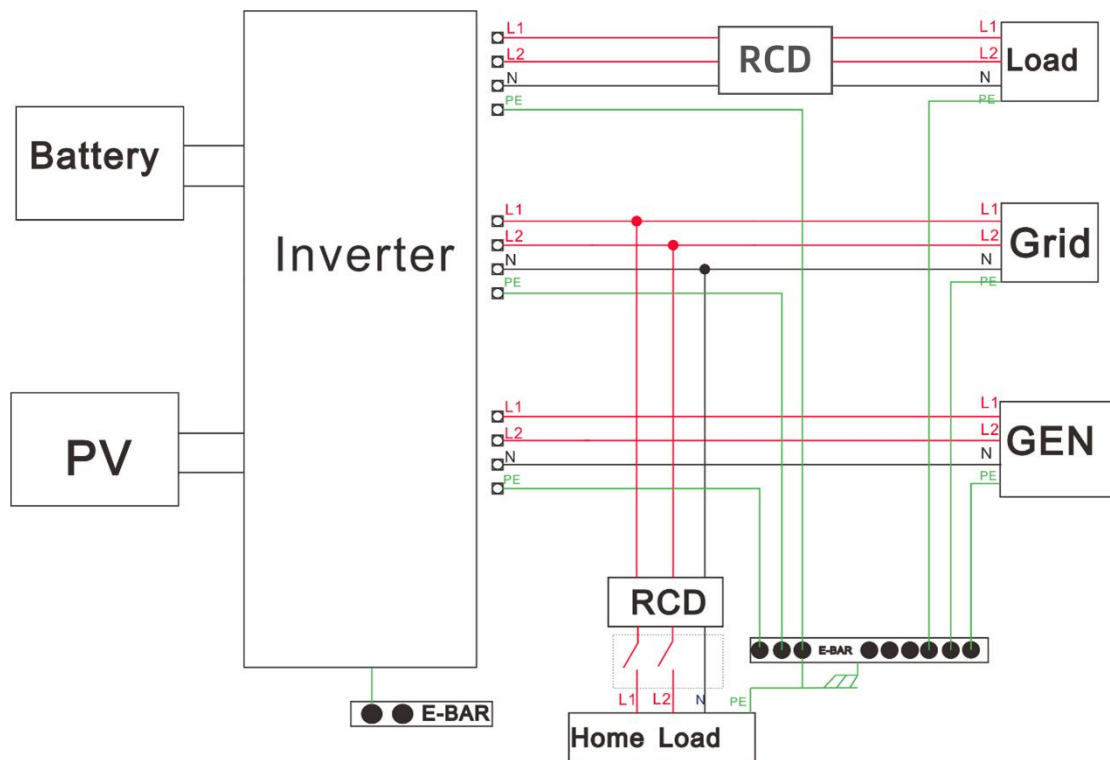

All switches and RCD devices in the figure are for reference only, and the specific installation shall be subject to local regulations.

**Note!**



- Please control the home loads, and make sure it's within the "BACK-UP output rating" under BACK-UP mode, otherwise the inverter will shut down with an "overload fault" warning.
- Please confirm with the mains grid operator whether there are any special regulations for grid connection.

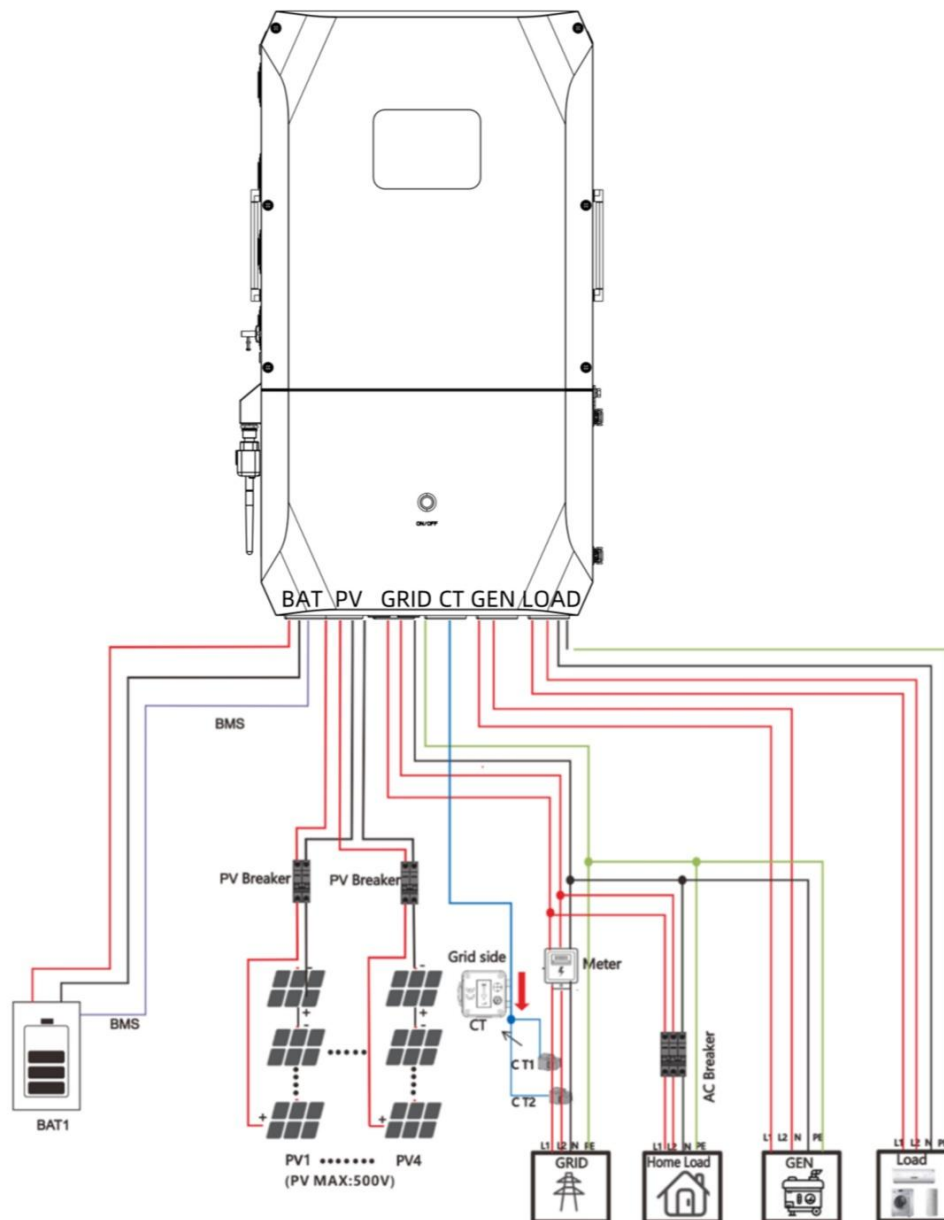

**Note!**



- The arrow on the CT points to the power grid, as shown.
- If the CT connector is improperly connected, the inverter cannot read the data correctly, so that the relevant working conditions cannot be realized normally.

### 3.3 Work Modes

Inverter provides multiple work modes based on different requirements.

Work modes: Self-consumption	
	<p>1. When PV, Grid, Battery is available:</p> <p>A. Solar energy provides power to the loads as first priority, if solar energy is sufficient to power all connected loads, solar energy excess power will provides to charge battery, and then reduntant power will feed to grid.</p>
	<p>B. Solar energy provides power to the loads as first priority ,if solar energy is not sufficient to power all connected loads, battery energy will supply power to the loads at the same time.</p>
	<p>C. Solar energy provides power to the loads as first priority ,if solar energy and battery are not sufficient to power all connected loads, utility energy (Main Grid) will supply power to the loads with solar energy at the same time.</p>
<p>2. When PV, Grid is available (without battery):</p>	
	<p>A. Solar energy provides power to the loads as first priority ,if solar energy is sufficient, the excess power will feed to grid.</p>
	<p>B. Solar energy provides power to the loads as first priority, if solar energy is not sufficient to power all connected loads, Grid energy will supply power to the loads at the same time.</p>
<p>3. When PV, Battery is available (Grid is disconnected):</p>	
	<p>A. Solar energy provides power to the loads as first priority ,if solar energy is sufficient to power all connected loads, solar energy will provides to charge battery.</p>
	<p>B. Solar energy provides power to the loads as first priority ,if solar energy is not sufficient to power all connected loads, battery energy and solar energy will supply power to the loads at the same time.</p>
Work modes: Peak shift	
<p>1. When PV, Grid, Battery is available:</p>	
	<p>A. On charge time, solar energy will charge battery as first priority. The excess energy will supply power to the loads. If solar energy is sufficient to supply loads and charge battery, and if there's still some extra energy, then the excess power will feed the power to grid</p>
	<p>B. On charge time, solar energy will charge battery as first priority. then the excess solar energy will supply power to loads. If solar energy is not sufficient to charge battery and supply loads, grid will supply all the connected loads with solar energy together.</p>
	<p>C. On discharge time, solar energy provides power to the loads as first priority, if solar energy is sufficient to supply loads ,and if there's still some extra energy from solar energy ,then the excess power and battery will deliver the power to the grid at the same time.</p>
	<p>D. In the period of no charge or discharge, the solar power supply loads at first priority , excess energy to the grid.</p>
<p>2. When Grid, Battery is available(PV is disconnected):</p>	
	<p>A. On charge time, grid will charge battery and supply power to the connected loads at the same time.</p>
	<p>B. On discharge time, if load power is less than battery power, battery will supply power to loads as first priority, the excess power will be feed to grid.</p>
	<p>C. On discharge time, if load power is more than battery power, battery and grid will supply power to the loads at the same time.</p>

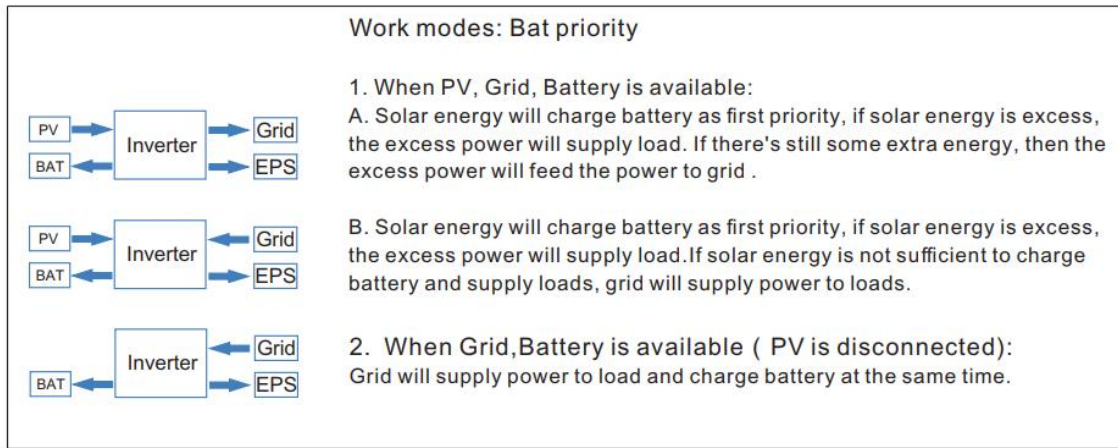

**Note!**

If set anti-Reverse function allowable, Once on the work mode of Self-use, Peak shift, battery priority, the system will not feed power to grid.

In addition to the above three basic modes, there is also an "Advanced Mode". Please refer to Chapter 10 for details.

### 3.4 Dimension

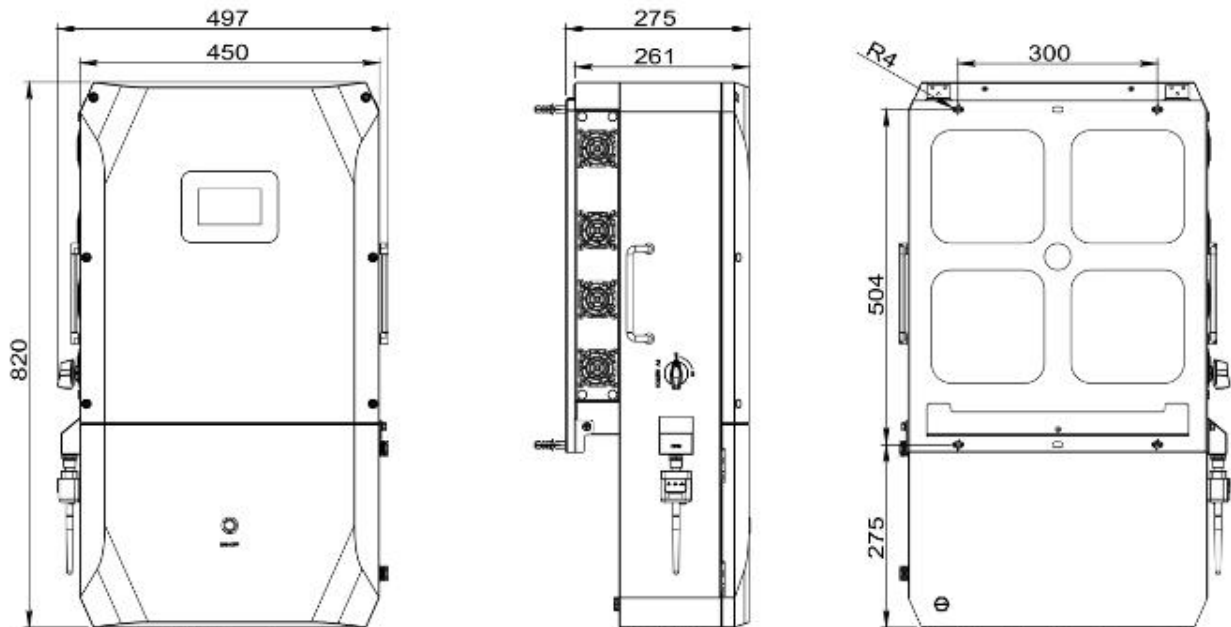

### 3.5 Terminals of PV inverter

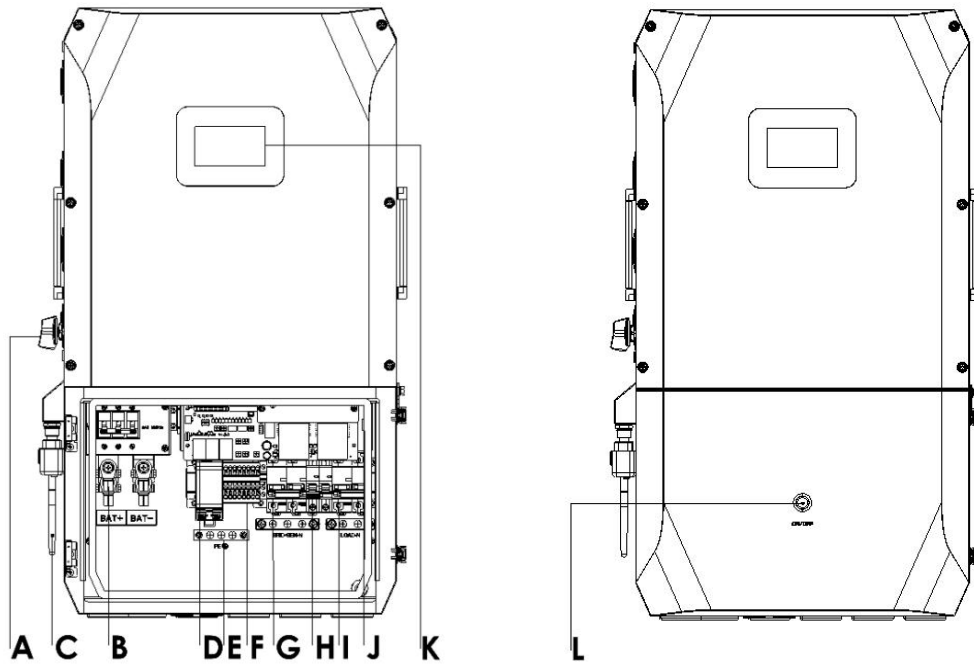

Object	Description
A	PV switch
B	BAT input
C	WiFi
D	CAN1/CAN2/Meter_RS485/BMS_CAN/485/CTL1L2/Type-C upgrade
E	PE
F	PV1~PV4 input
G	Grid
H	Generator
I	EPS load output
J	Screen firmware USB upgrade port
K	LED screen
L	RSD (ON/OFF) button

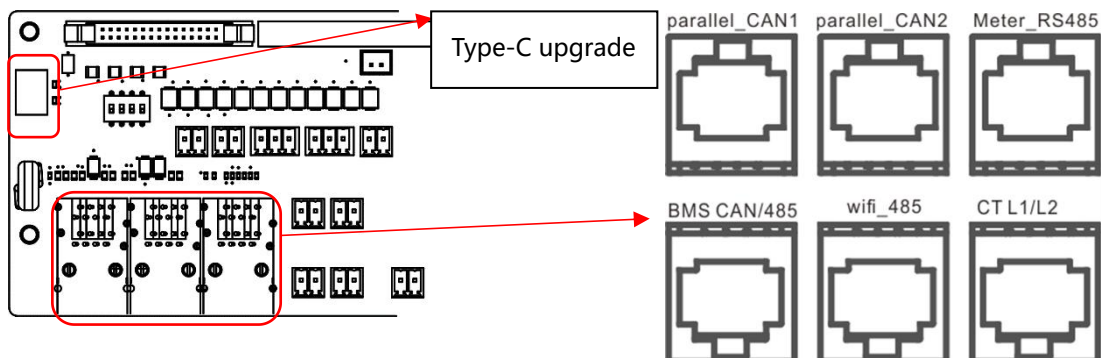

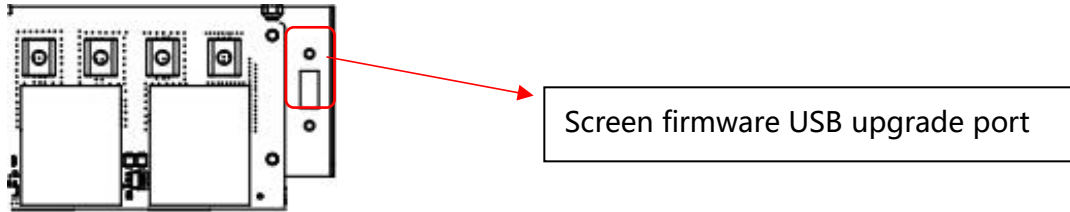

\* Port Function

CAN1/CAN2: Communication interface for connecting inverters.

Meter\_RS485: Read the inverter data and send it to the screen.

BMS-CAN: BMS communication for lithium batteries.

Wi-Fi\_485: Standby crystal port for the Wi-Fi module.

CT L1/L2: For external grid side CT to detect current size.

TYPE-C UPDATE: Update Inverter firmware locally via PC.

Screen firmware USB upgrade port: Upgrade the screen firmware using the USB port.

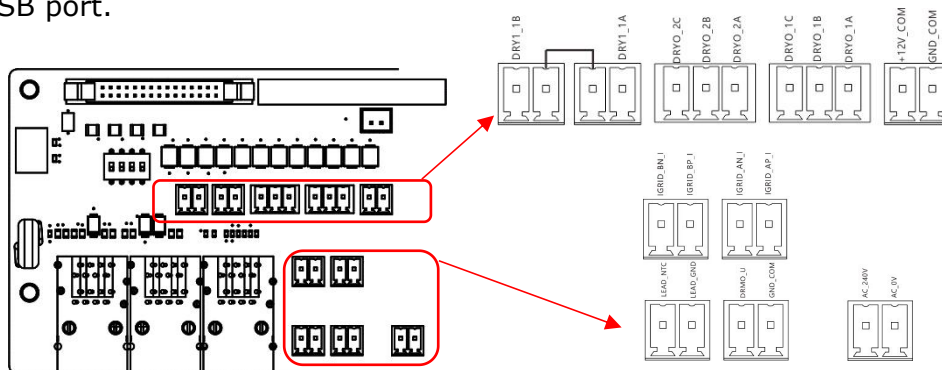

DRY1\_1B/DRY1\_1: Used to start the Inverter driver.

DRY0\_2A and DRY0\_2B (dry contact, normally closed): Reserved dry contact port.

DRY0\_2A and DRY0\_2C (dry contact, normally open): Reserved dry contact port. (mutually exclusive with DRY0\_2B and DRY0\_2A).

DRY0\_1A and DRY0\_1B (dry contact, normally open): For generators, dry contact closure, generator start, dry contact disconnection, generator shutdown.

DRY0\_1A and DRY0\_1C (dry contact, normally closed): mutually exclusive with DRY0\_1B and DRY0\_1A.

+12V\_com/GND com: Used to connect E-stop.

IGRID\_BN\_I/ IGRID\_BP\_I: CT standby cable port.

IGRID\_AN\_I / IGRID\_AP\_I: CT standby cable port.

LEAD\_NTC/ LEAD\_GND: Lead-acid battery temperature sampling input interface.

DRMO\_U / GND\_COM: Reserved dry contact port.

AC\_240V/AV-0V: AC240V isolated output interface.



**WARNING!**  
Qualified electrician will be required for the installation.



## 4. Technical Parameters

### 4.1 Inverter specification

Technical Data	N3H-X5US	N3H-X8US	N3H-X10US
<b>PV Input Data</b>			
Max. DC Input Power	7.5kW	12KW	15kW
NO. MPPT Tracker	4		
MPPT operating Range	120 - 430V		
Max. DC Input Voltage	500V		
Max. Input Current	14A*4		
Max. Short Circuit Current	22A		
<b>Battery Input Data</b>			
Nominal voltage (Vdc)	48V	48V	48V
Max. Charging/Discharging Current	120A/120A	190A/190A	190A/210A
Battery Voltage Range	40-60V		
Battery Type	Lithium and Lead Acid Battery		
Charging Strategy for Li-Ion Battery	Self-adaption to BMS		
<b>AC Output Data (On-Grid)</b>			
Nominal output power Output to Grid	5kVA	8kVA	10kVA
Max. Apparent Power Output to Grid	5.5kVA	8.8kVA	11kVA
Output Voltage Range	110-120/220-240V split phase, 208V(2/3 phase), 230V(1 phase)		
Output Frequency	50/60Hz (45 to 54.9Hz / 55 to 65Hz)		
Nominal AC Current Output to Grid	20.8A	33.3A	41.7A
Max.AC Current Output to Grid	22.9A	36.7A	45.8A
Output Power Factor	0.8leading...0.8lagging		
Output THDI	< 2%		
Max. Grid Passthrough Current	100A		
<b>AC Output Data (Back-Up)</b>			
Nominal. Apparent Power Output	5kVA	8kVA	10kVA
Max. Apparent Power Output	5.5kVA	8.8kVA	11kVA
Nominal Output Voltage L-N/L1-L2	120/240V		
Nominal Output Frequency	60Hz		
Output THDU	< 2%		

<b>Efficiency</b>	
Europe Efficiency	>=97.8%
Max. Battery to Load Efficiency	>=97.2%
<b>Protection</b>	
Grounding detection	YES
Arc Fault Protection	YES
Island Protection	YES
Battery reverse Polarity	YES
Insulation Resistor Detection	YES
Residual Current Monitoring Unit	YES
Output Over Current Protection	YES
Back-up Output Short Protection	YES
Output Over Voltage Protection	YES
Output Under Voltage Protection	YES
<b>General Data</b>	
Output Conduit	25.4mm
PV Input Conduit	25.4mm
BAT Input Conduit	34.5mm
Operating Temperature Range	-25 ~ +60°C ( > 45°C derating)
Relative Humidity	0-95%
Operating Altitude	0~4000m
Ingress Protection	IP65/Type 3R
Weight	48kg
Size (Width*Height*Depth )	450mm x 820mm x 261mm
Cooling	Air Cooling
Noise emission	<38dB
Display	LED
Communication With BMS/Meter/EMS	RS485, CAN
Supported communication interface	RS485, WLAN, 4G (optional)
Self-consumption	< 25 W
Safety	UL1741SA all options, UL1699B, CSA 22.2
EMC	FCC Part 15 Class
Grid connection standards	IEEE 1547, IEEE 2030.5, Hawaii Rule 14H, Rule 21 Phase I, II, III

## 5. Installation

### 5.1 Check for Physical Damage

Make sure the inverter is intact during transportation. If there is any visible damage, such as cracks, please contact your dealer immediately.

### 5.2 Packing List

Open the package and take out the product, please check the accessories first. The packing list shown as below.

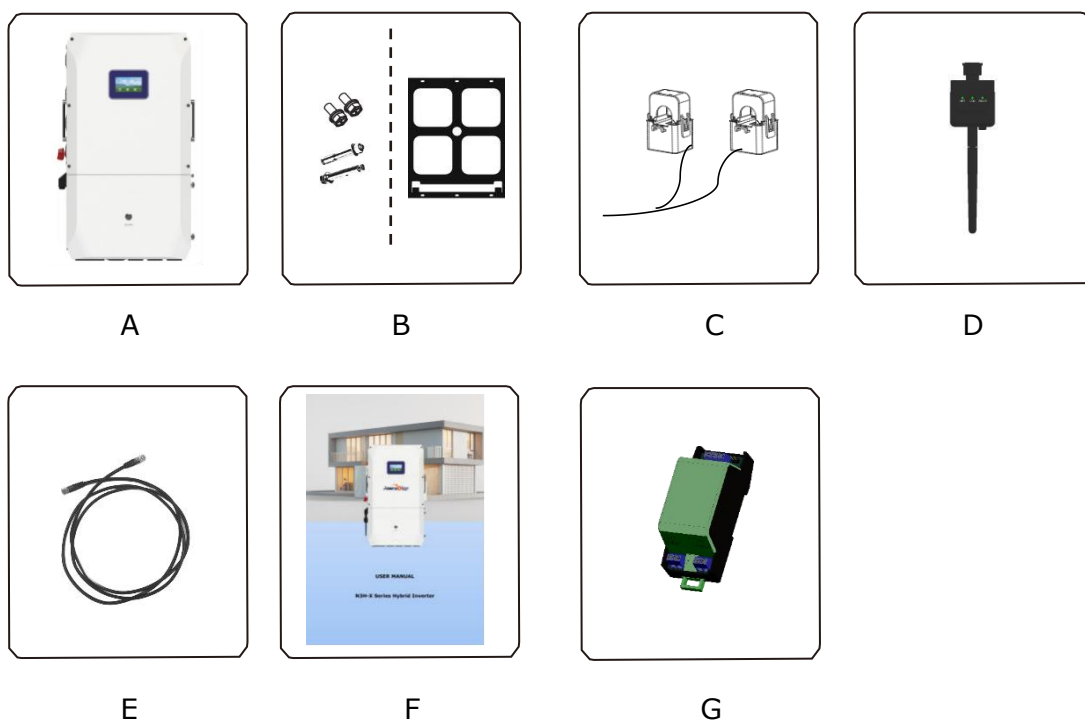

Object	Description
A	Inverter
B	Expansion screws and pan-head screws, Hanging rack
C	CT (CTSA035-200A-100mA, inner radius35mm)
D	Wi-Fi module
E	2m Parallel Machine Line
F	User manual
G	Rapid shutdown system transmitter (optional)

## 5.3 Mounting

### ➤ Installation Precaution

Inverter is designed for outdoor installation (IP65). Make sure the installation site meets the following conditions:

- ◆ Not in direct sunlight.
- ◆ Not in areas where highly Flammable materials are stored.
- ◆ Not in potential explosive areas.
- ◆ Not in the cool air directly.
- ◆ Not near the television antenna or antenna cable.
- ◆ Not higher than altitude of about 2000m above sea level.
- ◆ Not in environment of precipitation or humidity (> 95%).
- ◆ Under good ventilation condition.
- ◆ The ambient temperature in the range of -20°C to +60°C.
- ◆ The slope of the wall should be within  $\pm 5^\circ$ .

◆ The wall hanging the inverter should meet conditions below:

1. Solid brick/concrete, or strength equivalent mounting surface;
2. Inverter must be supported or strengthened if the wall's strength isn't enough (such as wooden wall, the wall covered by thick layer of decoration)

Please AVOID direct sunlight, rain exposure, snow laying up during installation and operation.

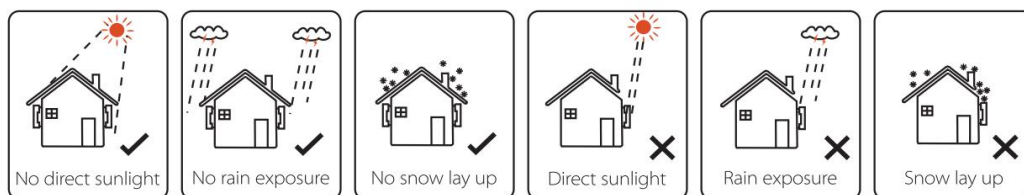

➤ **Space Requirement**

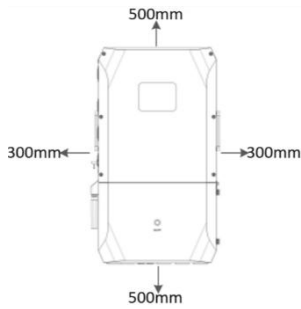

Position	Min. size
Left	300mm
Right	300mm
Top	500mm
Bottom	500mm
Front	1000mm

➤ **Mounting**

Tools required for installation.

Installation tools: crimping pliers for binding post and RJ45, screwdriver, manual wrench etc.



**Step 1:** Drill 4 holes in the wall according to the following distance dimensions, 50~60mm depth. Then use a proper hammer to fit the expansion bolt into the holes.

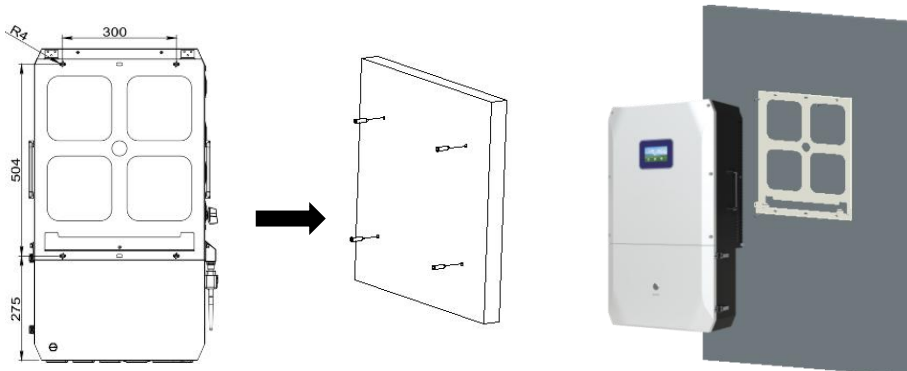

**Step 2:** Attach the Hanging rack to the wall using 4 expansion screws. Lift the inverter, place the inverter on the Hanging rack, and tighten the screws on both sides of the lower part.

**Step 3:** Install an anti-theft lock on DC switch of the inverter.



**Step 4:** The two latches on the lower right of the inverter open upward to open the waterproof cover. If you need to remove the display panel on the top half of the machine, use a hexagonal screwdriver to remove the six screws on the top. Wiring box conduit plugs, Conduit plugs are provided for 1inch conduit fittings. If used conduit fitting is not 1 inch, an appropriate conduit adaptor should be used.

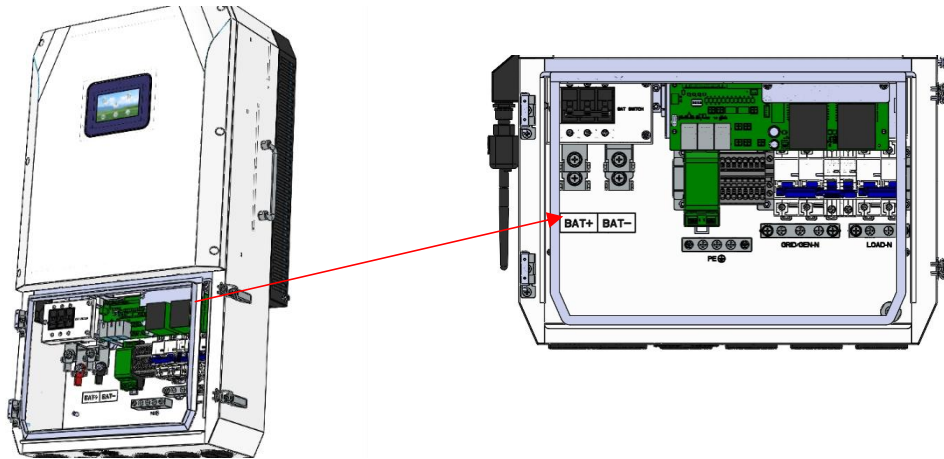

**Step 5:** Pass the corresponding conduit and fasten the joint.

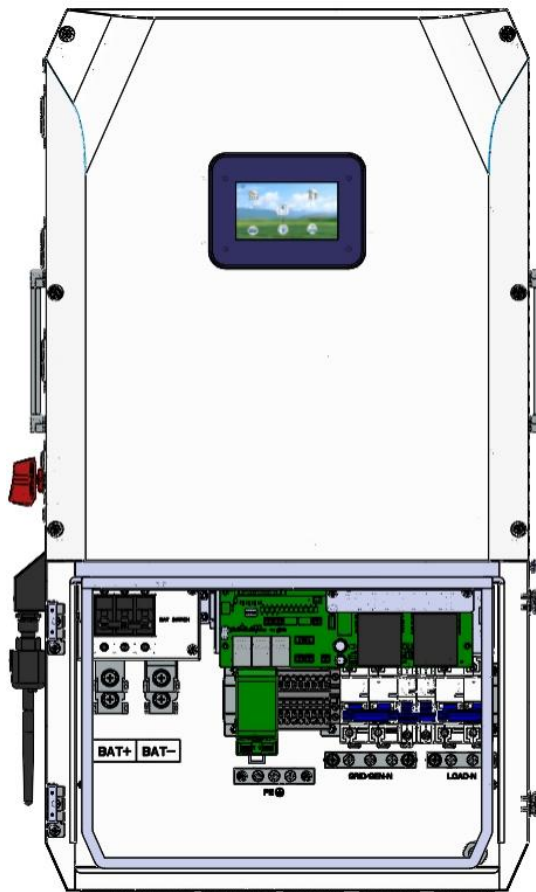

## 6. Electrical Connection

### 6.1 PV connection

Hybrid can be connected in series with 4-strings PV modules for 5kw, 6kw, 7.6kw, 8kw, 10kw. Select PV modules with excellent function and reliable quality. Open-circuit voltage of module arrays connected in series should be less than Max. DC input voltage; operating voltage should be conformed to MPPT voltage range.

**Warning!**



- PV module voltage is very high, which already achieve dangerous voltage range, please comply with electric safety rules when connecting.
- Please do not make PV positive or negative ground!

**Note!**



- The following requirements of PV modules need to be applied for each input area.
- Please do not make PV positive or negative ground!
- In order to save cable and reduce the DC loss, we suggest installing the inverter near PV modules.

#### Step1. Wiring.

- 1.1 Choose the 12 AWG wire to connect with the cold-pressed terminal.
- 1.2 Remove 18mm of insulation from the end of wire.

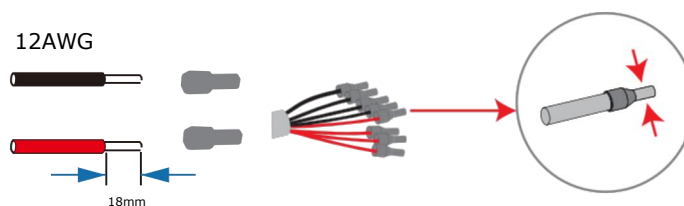

#### Step2. Cross the PV cables through the PV port, Connect PV cables to PV terminals.

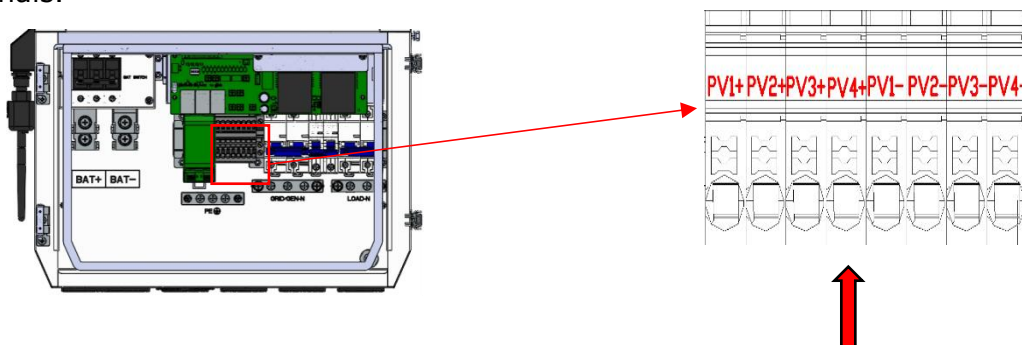

## 6.2 Grid Connection (GEN connection)

**Step1.** Check the grid voltage.

- 1.1 Check the grid voltage and compare with the permissive voltage range (Please refer to technical data).
- 1.2 Disconnect the circuit board from all the phases and secure against re-connection.

**Step2.** Grid cables selection

Use the right pin terminal from the accessory box. Press the connectors on cable conductor core tightly.

Model	N3H-X5US	N3H-X8US	N3H-X10US
Cable	5AWG	5AWG	5AWG

**Step3.** Select the wire to connect with the cold-pressed terminal.

(Remove 18mm of insulation from the end of wire.)

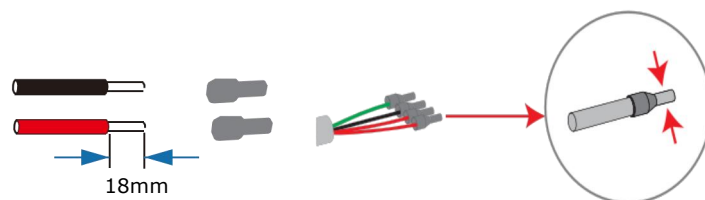

**Step4.** Cross the Grid cables through the grid port, Connect Grid cables to Grid terminals.

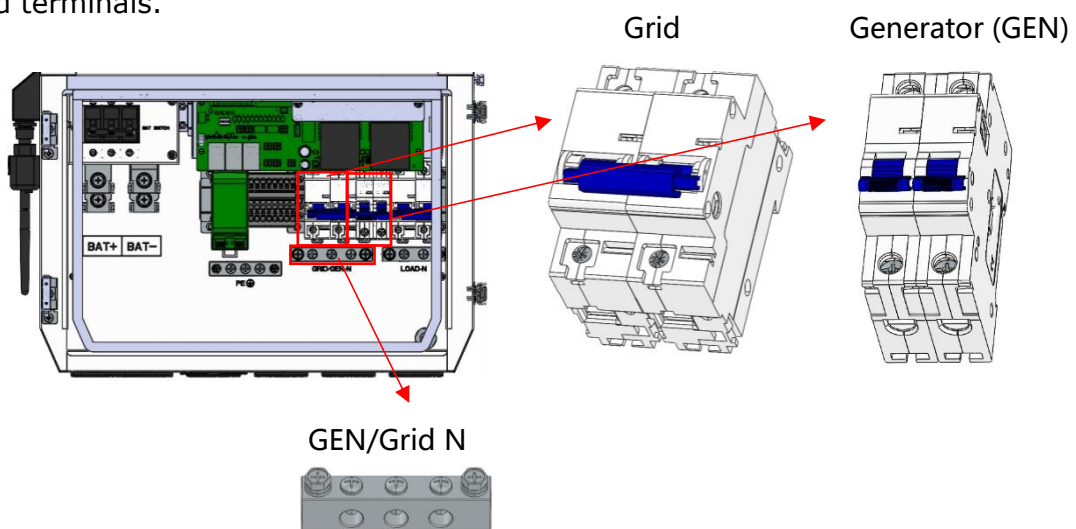



## 6.3 Back-up: Load Connection

Inverter has On and Off grid function, the inverter will deliver output power through AC port when the grid is on, and it will deliver output power through back-up port when the grid is off.

➤ **Load port: important load:**

1) . For inverter, the standard PV installation typically consists of the connecting the inverter with both panels and batteries. In the event that batteries aren't connected into the system, it's strongly advised against using the system as a back-up. If the system is used as a back-up as mentioned here, Damages will not be covered under the standard warranty and the manufacturer will not be liable for consequences arising as result of the user not following this instruction.

2) . Hybrid inverters are able to supply overload output as its "Back-Up". For details, please refer to the technical parameters of inverter. And the inverter has self-protection de-rating at high ambient temperature.

3). For complicated application, or Special load, please contact after-sales team.

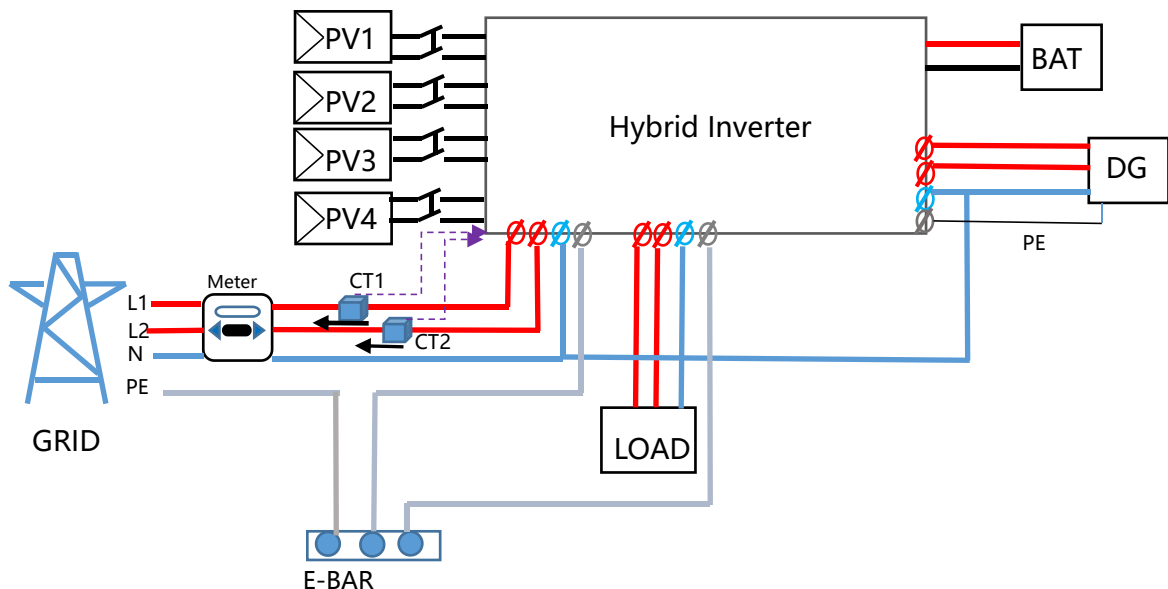

**Note!**

In case of discrepancies between wiring mode of local policy and the operation guide above, especially for the wiring of neutral line, grounding, and RCD, please contact us before any operation!

➤ **Back-Up: Load Connection:**

Model	N3H-X5US	N3H-X8US	N3H-X10US
Micro-breaker	32A	40A	63A

**Note:** The absence of a AC breaker on the back-up side will lead to inverter damage, if an electrical short circuit happens on the back-up side.

**Step1.** Make BACK-UP wires.

Model	N3H-X5US	N3H-X8US	N3H-X10US
Cable	5AWG	5AWG	5AWG

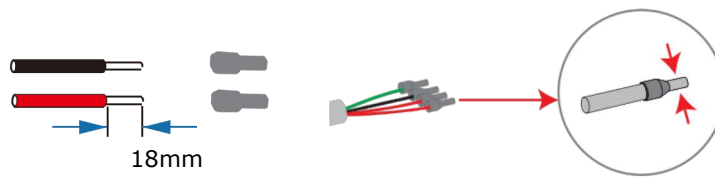

**Step2.** Connect the cables to the BACK-UP: Load port of the inverter.

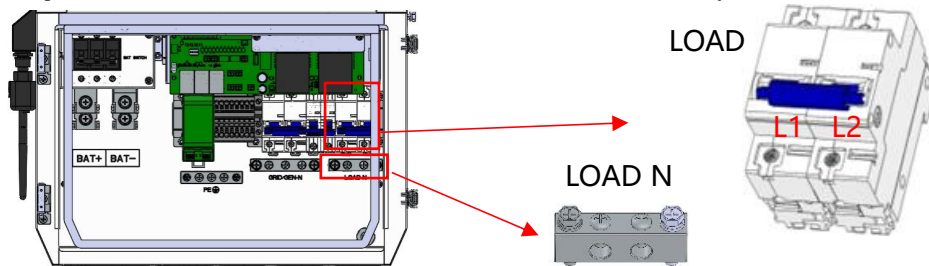

➤ **Requirements for BACK-UP load**

**Warning!**

- Make sure the BACK-UP load power rating is within BACK-UP output rating, otherwise the inverter will shut down with an "over load" warning.
- When an "over load" appears, adjust the load power to make sure it is within the BACK-UP output power range, then turn the inverter back on.
- For the nonlinear load, please make sure the inrush power should be within the BACK-UP output power range.

**Warning!**

- We have a common mode inductor between the GRID port and the LOAD port, short GRID-N and LOAD-N outside will damage this filter inductor.
- If using this interface to support load, please ensure that the N line of the load is connected to the "LOAD-N" port . DO NOT connect "Load-N" to "GRID-N" directly.

## 6.4 Battery Connection

The charging & discharging system of the Hybrid series inverter is designed for a 48V lithium battery.

Before choosing a battery, please note the maximum voltage of the battery, it can't exceed 60V and the battery communication should be compatible with the Hybrid inverter.

### ➤ Battery breaker

A 250 A non-polarized DC circuit breaker has been installed at the positive battery connection end of the inverter to ensure that the inverter can be safely disconnected for maintenance. If you need to add a DC breaker at the negative terminal, add it yourself.

Model	N3H-X5US	N3H-X8US	N3H-X10US
Current[A]	160A	250A	
Cable	4PCS 5AWG (2+,2-)	4PCS 2AWG (2+,2-)	

### ➤ Battery connection diagram

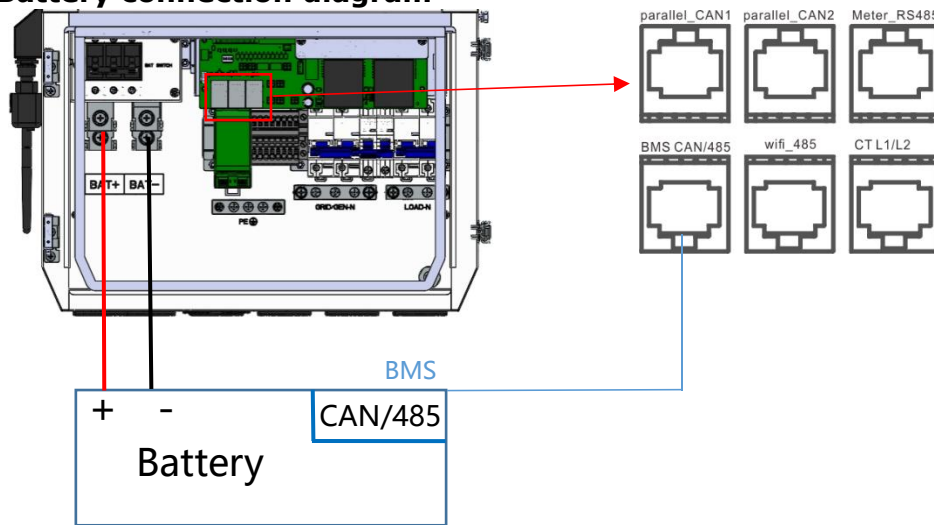

### ➤ BMS PIN Definition

Communication interface between inverter and battery is RS485 or CAN with a RJ45 connector.

	PIN	1	2	3	4	5	6	7	8
	CAN	X	X	X	BMS_CANH	BMS_CANL	X	X	X
	RS485	X	X	X	X	X	GND	BMS_485A	BMS_485B

When using RS485 protocol, please note that PIN2 must be disconnected!

#### Note!



The battery communication can only work when the battery BMS is compatible with the inverter.

➤ Power Connection Battery:

**Step1**

Choose the Cable wire and strip 15mm off the cable. Select four O-terminals with an aperture of M8. Insert the stripping line into the O-terminal and clamp it with a crimping clamp.



**Step2.** Insert the battery cable through the battery port. Connect the battery cable to the correct battery terminal.

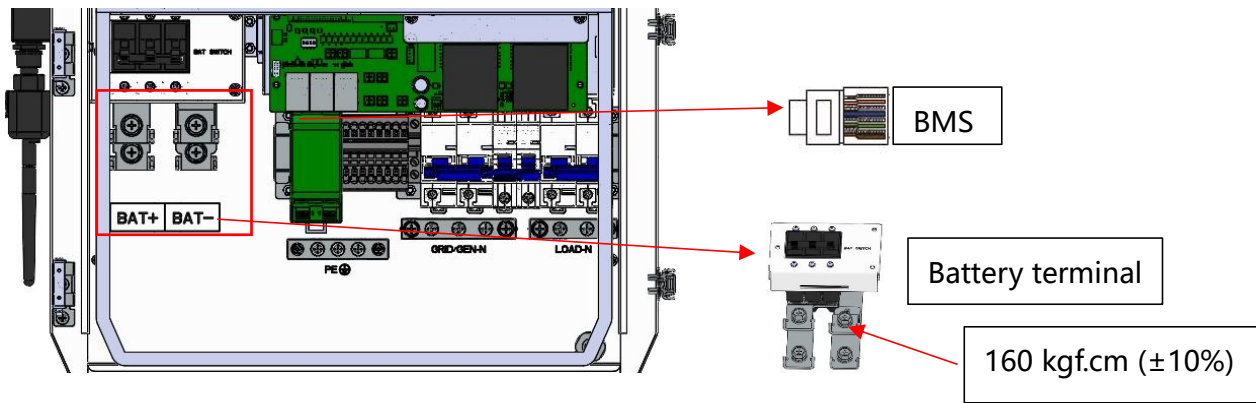

**Note!**

Positive and negative wires are not allowed to reverse.

**6.5 Wi-Fi Connection**

Inverter provides a Wi-Fi port which can collect data from inverter and transmit it to monitoring-website by Wi-Fi.

**1) Diagram**

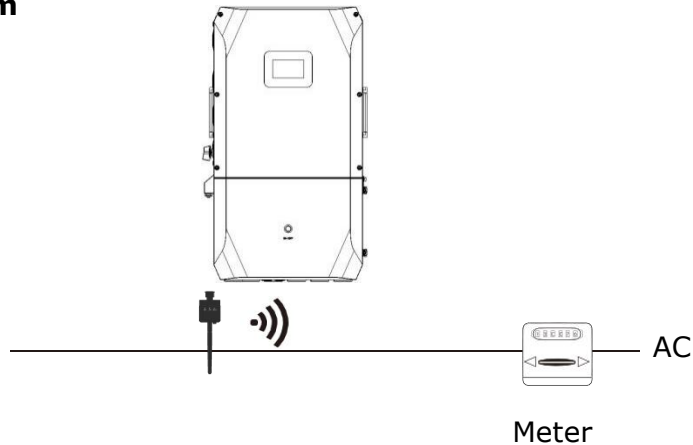

**2)Wi-Fi Connection:**

**Step1.** Plug Wi-Fi into “Wi-Fi” port at the bottom of the inverter.

**Step2.** Build the connection between the inverter and router.

**Step3.** Create a user account online. (Please check the Wi-Fi user manual for more details)

**6.6 CT Installation instructions**

CT is short for “current transformer”, it's used to detect Grid current. The hybrid inverter provides the CTSA035-200A-100mA B2 CT device by default, which has a 2000:1 sampling ratio.

If the customer uses a third-party CT device, please ensure that the device meets the UL2808 standard.

When connected to split phase power grid (North America), the accessories provide two CTS, “CT-L1” network interface is connected to L1 phase, and “CT-L2” network interface is connected to L2 phase. The arrow direction of CT points to the power grid.



**Note!**

- If CT is not installed or installed reversely, the functions of "Sell Enable", "Self Consumption", "Peak-shift "... will not be realized.
- The direction of the arrow on the CT, points from this inverter to the GRID!

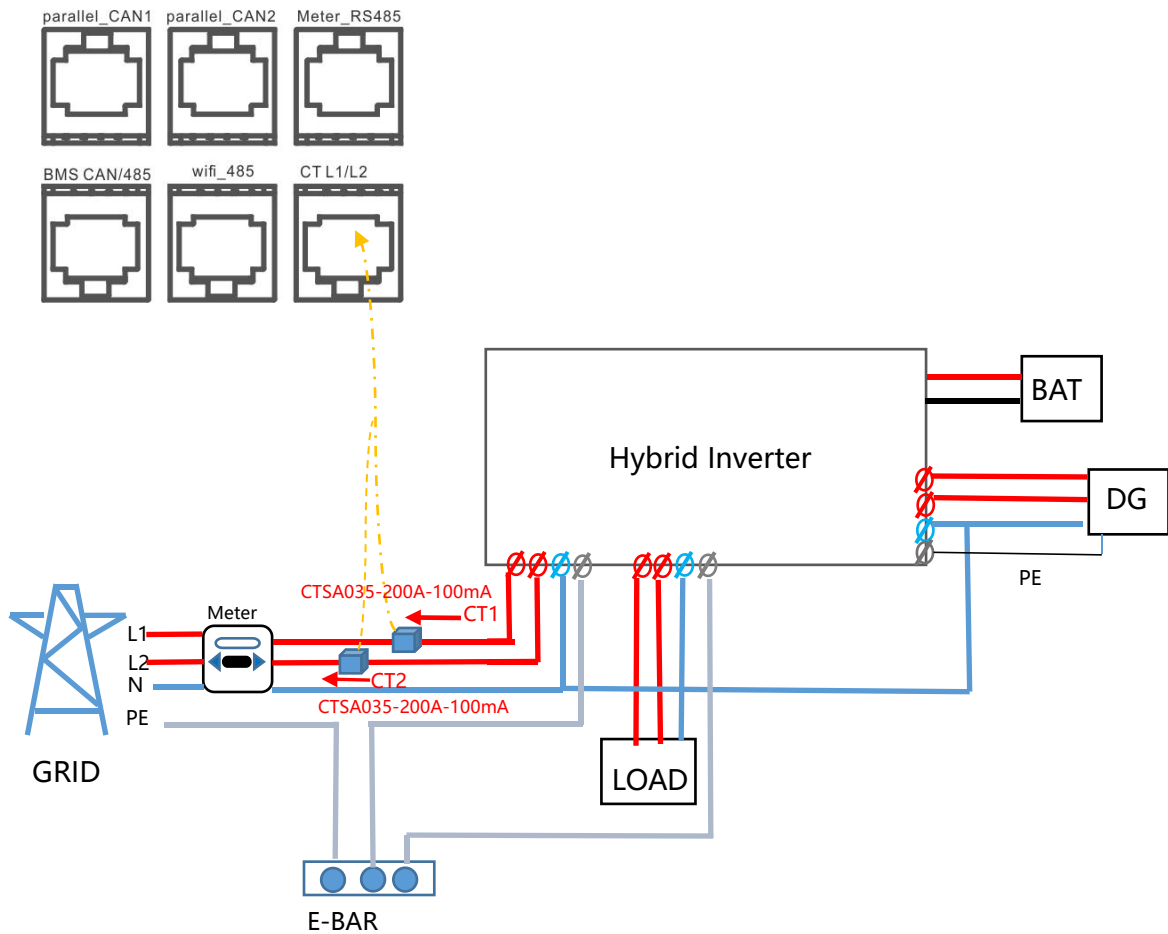

## 6.7 RSD (ON/OFF) Installation

RSD function and ON/OFF function are the same button.

**ON/OFF** : The button is connected to dry contacts "DRY1\_1B" and "DRY1\_1A" through two terminals, if the two terminals are both shorted, the inverter will power on. In addition, the inverter reserves a remote power off terminals. The contact has been shorted before delivery. If necessary, customers can connect an external switch to control the inverter ON and OFF.

**RSD**: short for "rapid shutdown". PV system circuits installed on or in buildings include a rapid shutdown function to reduce shock hazard for emergency responders.

Press up this button to power off the 12V ("12V\_COM") which is for the "RSD Transmitter", the "RSD Transmitter" is power off, then all PV modules will shut down.

**DC switch**: PV input switch.

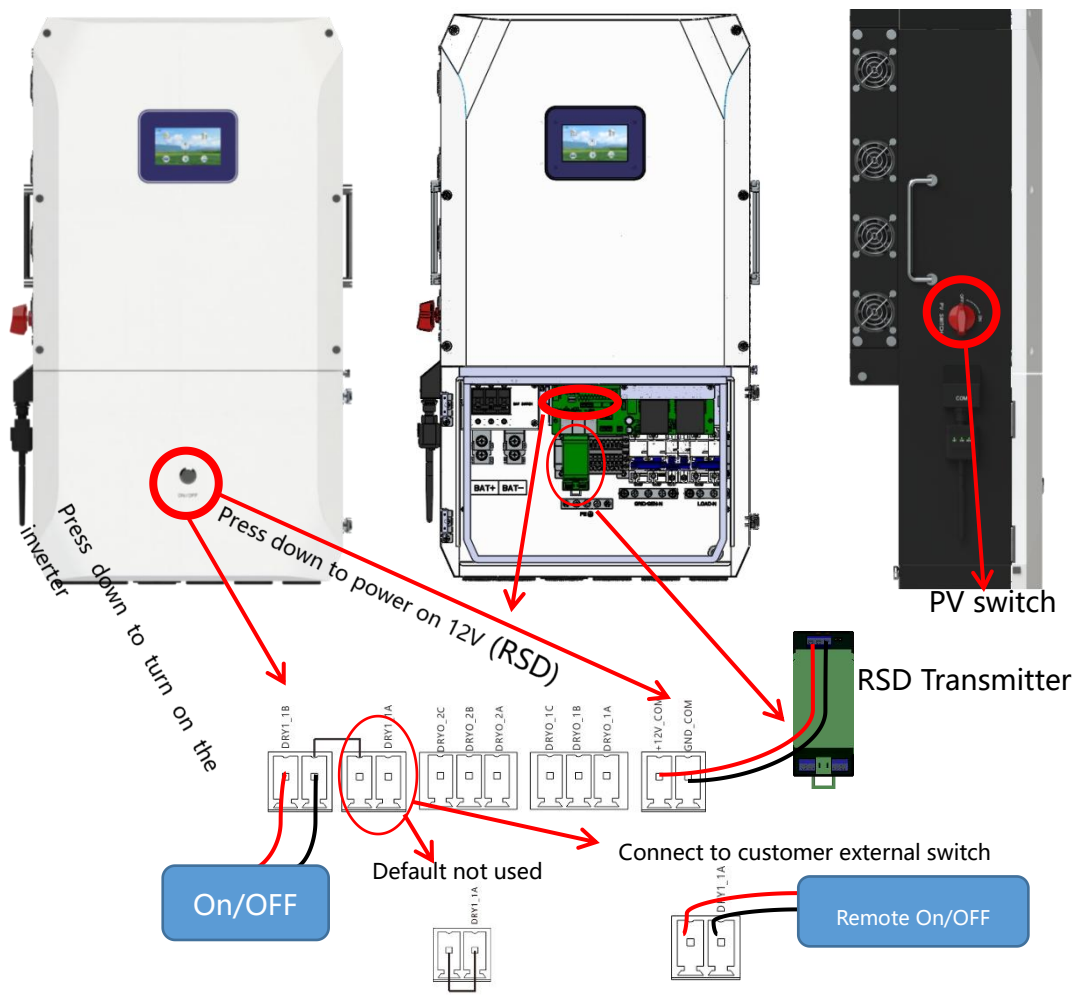

## 7. LED Operation

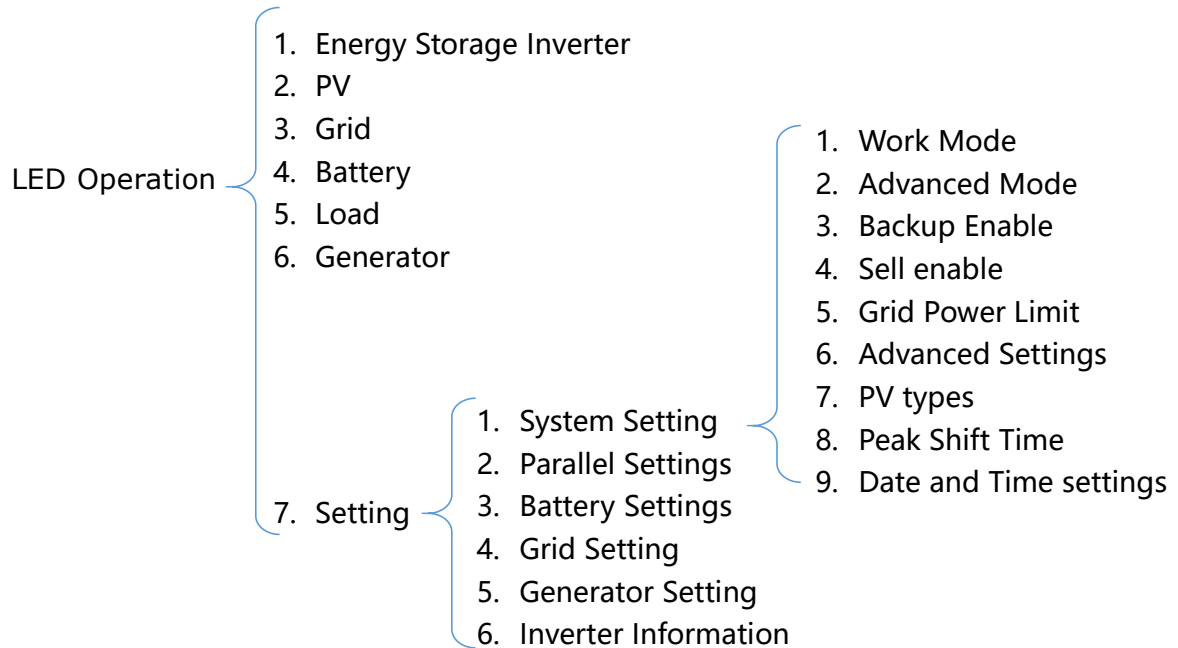

Abbreviation interpretation:

Abbreviation	Explanation	Abbreviation	Explanation
RSD	Rapid Shutdown	TOU	Time-of-use
CV	Constant voltage	DOD	Depth of discharge
EPS	Emergency Power System	E-TODAY	Energy-Today
ZeroExportP	Zero Export Power	GRID HYST	GRID Hysteresis
BAT COM	Battery Communication		

How to use the Hybrid Inverter.



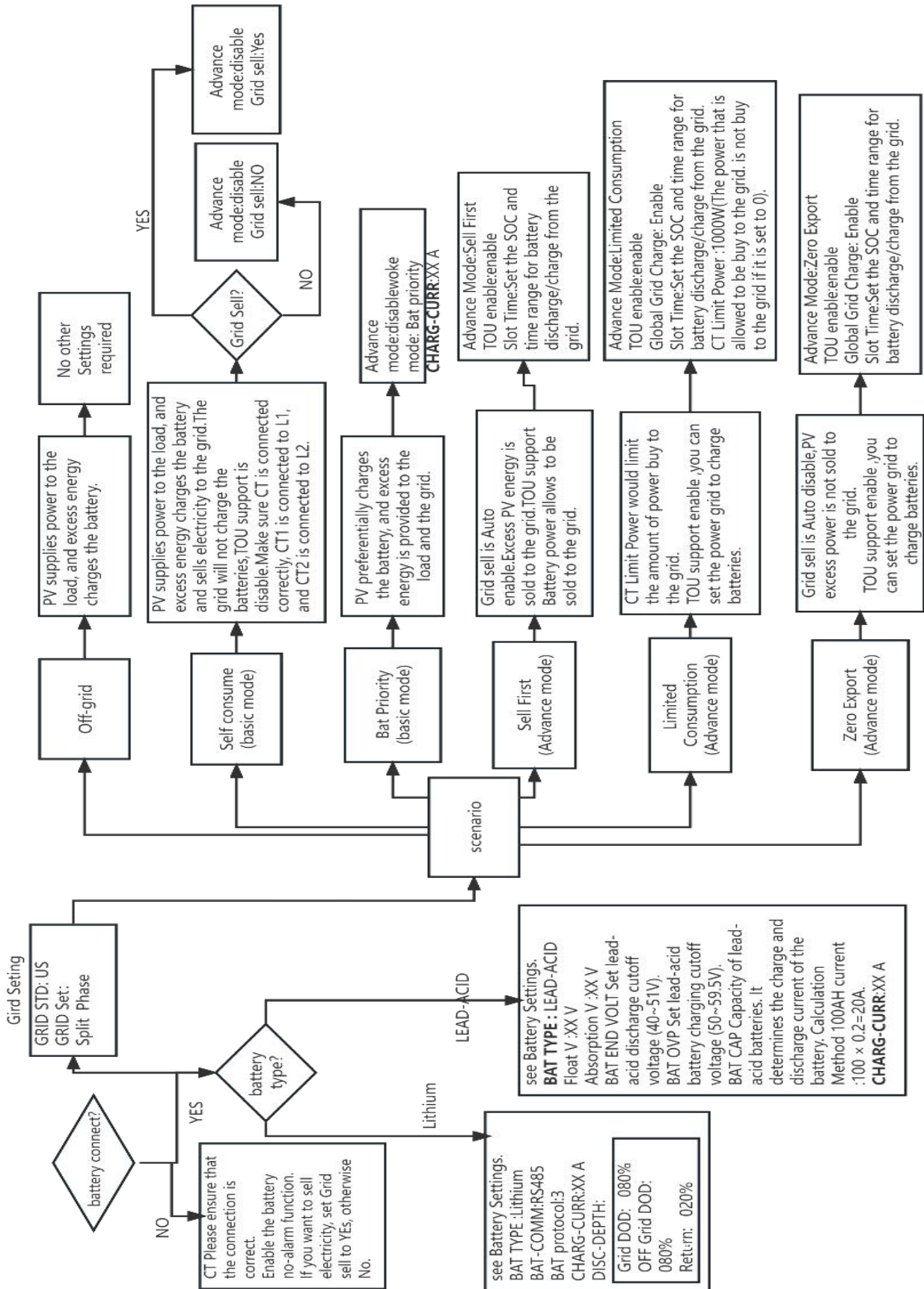

## 7.1 Control Panel

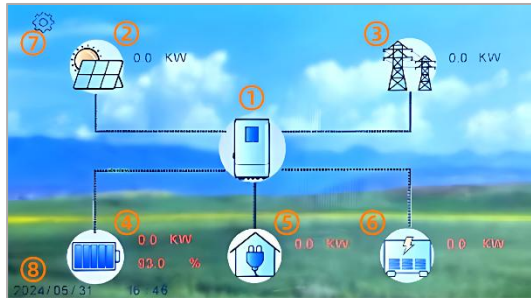

Code	Name	Explanation
1	Energy Storage Inverter	Click Energy Storage Inverter to enter the working status interface of the energy storage inverter.
2	PV	Display the real-time PV power. Click PV to enter the working status interface of PV.
3	Grid	Display the real-time grid power. Click Grid to enter the working status interface of grid.
4	Battery	Display the real-time battery power and percentage of battery surplus capacity from the BMS. Click Battery to enter the working status interface of battery.
5	Load	Display the real-time load power. Click Load to enter the working status interface of load.
6	Generator	Display the real-time generator power. Click generator to enter the working status interface of generator.
7	Setting	Users can click Setting to enter the settings interface.
8	Data/Time	Date and time of the inverter.

Note: It takes 2 seconds to upload the data to the screen. Please wait patiently.

## 7.2 Working Status

### 7.2.1 Energy Storage Inverter

<p>① Users can click on the icon above to switch device status data (PV, Battery,</p>	<p>④ Display status information, including System status, Inverter status, and DCDC status.</p> <p><b>System Status:</b> Display complete Inverter status information, include INIT, STANDBY, PV GRID, BAT GRID, BYP, AC BAT CHG, HYBRID POW etc.</p> <p><b>INV:</b> Displays the inverter status information, including: STANDBY, OFF GRID, GRID, OFF GRID PL, INV TO PFC.</p>
---	---

<p>Energy Storage Inverter, Load, Grid, BUS) and return to the Home Page. (not to be repeated later)</p> <p>② <b>VPBUS</b>: Real-time voltage of bus capacitor of the Inverter.</p> <p><b>VnBUS</b>: Real-time voltage of bus capacitor of the Inverter.</p> <p>③ Temperature</p> <p><b>INV-T(°C)</b>: INV Temperature</p> <p><b>Inside-T(°C)</b>: Internal ambient temperature of the Inverter.</p>	<p><b>GRID</b>: Grid connected state.</p> <p><b>OFF-GRID</b>: Off-GRID working state.</p> <p><b>OFF GRID PL</b>: Working state of off-grid conversion to grid connection.</p> <p><b>INV TO PFC</b>: Status of power by public grid turn into on grid working mode.</p> <p><b>DCDC Status</b>: Displays charging and discharging status information, include STANDBY, CHARGE, DISCHARGE.</p> <p>⑤ <b>Leak current</b>: Real-time leak current of the Inverter.</p> <p>⑥ Display the <b>real-time voltage, current, and power</b> of the device.</p>
--	--

### 7.2.2 PV

	<p>① Display the working parameters of the four channels of PV (<b>PV1, PV2, PV3, PV4</b>), including <b>real-time voltage, current, and power</b>. (PV input type can be set in the settings).</p> <p>② Display the cumulative charging capacity of the PV, including daily and total accumulated energy.</p>
--	--

### 7.2.3 Grid

	<p>① Display the working parameters on the grid, including <b>Frequency, real-time voltage, real-time current, and real-time power</b>.</p> <p>② Accumulated energy from the power grid to the equipment(Buy) and accumulated energy from equipment to the power grid(Sell), including daily and total accumulated energy.</p>
--	--

### 7.2.4 Battery

① Display the working parameters of the battery, including **real-time voltage, real-time current, battery surplus capacity, battery temperature, battery power, and battery type.**

② Display battery **charging voltage, charging current, and discharge current.**

③ Three working states of batteries ( from BMS ) , including **charging, discharging, and forced charging.**  
Charge EN : Charge Enable Discharge EN: Discharge Enable.

④ Accumulated discharge and charging capacity of the battery, including daily and total accumulated energy.

### 7.2.5 Load

#### 7.2.5.1 Load/Page One

① Display the working parameters of the load, including **real-time voltage, current, and power.**

② Accumulated usage of load, including daily and total accumulated energy.

User can click « to return to the previous page, and click » to enter the next page. (not to be repeated later)

#### 7.2.5.2 Load/Page Two

When set Home load EN to "ENABLE", if you have a load connected to the mains port, you can see its Home load power.

## 7.2.6 Generator

	<p>Display the working parameters of the generator, including <b>real-time voltage, current, and power.</b></p>
--	---

## 7.3 Setting

### 7.3.1 Enter Setting

#### 7.3.1.1 Input password

	<p>①Users can click on the icon above to enter device status data (<b>PV, Battery, Energy Storage Inverter, Load, Grid, Generator</b>) and return to the Home Page.</p> <p>②To enter the settings, a password is required. The default password is 11111. Click OK to enter the settings interface.</p>
--	---

#### 7.3.1.2 Enter the settings interface

	<p>Users can click on the icon above to switch between setting options, Inverter related information, and return to the Home Page.</p>
--	--

- : System Setting
- : Parallel Setting
- : Battery Setting
- : Grid Setting
- : Generator Setting
- : Inverter Information
- : Return Home Page

 : After modifying the parameters, the user needs to click on this icon to confirm the modification.

### 7.3.2 Setting Option

#### 7.3.2.1 System Setting/ Page One:

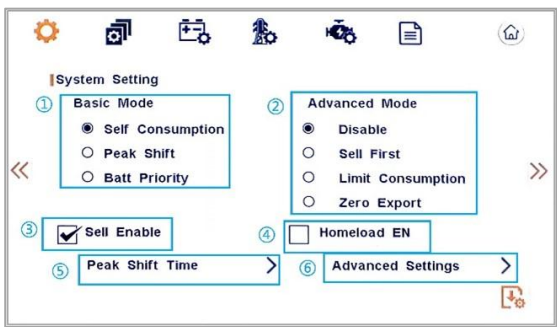

The screenshot shows the 'System Setting' interface. It has a top navigation bar with icons for settings, system, inverter, battery, and a home button. The main content area is divided into two columns. The left column contains: 1. 'Basic Mode' with radio buttons for 'Self Consumption', 'Peak Shift', and 'Batt Priority'. 2. 'Sell Enable' with a checked checkbox. 3. 'Peak Shift Time' with a right-pointing arrow. The right column contains: 2. 'Advanced Mode' with radio buttons for 'Disable', 'Sell First', 'Limit Consumption', and 'Zero Export'. 4. 'Homeload EN' with an unchecked checkbox. 6. 'Advanced Settings' with a right-pointing arrow. A confirm icon is at the bottom right.

① **Basic Mode:**  
Users have three Basic modes to choose from, **Self Consumption**, **Peak Shift**, and **Battery Priority**.

② **Advanced mode:**

There are four options here: Disable, Sell First Mode, Limited Consumption Mode and Zero Export Mode. For details about advanced modes, see Chapter 10.

③ **Sell Enable:** Whether the inverter is allowed to sell electricity to the grid. The option is checked, which means that the inverter can generate electricity to the grid, **If this option is not selected, the inverter is prohibited from selling power to the power grid.**

④ **Home load EN:** After this function is enabled, home load statistics is enabled for the inverter and power is correctly displayed.

⑤ **Peak Shift time:** Click to enter the Peak Shift mode time period setting interface.

⑥ **Advanced Settings:**

Users can click  to enter the advanced settings interface. There are also some attributes of these mode: Global Grid Charge Enable, PV Charge Only, Bat Charge on Priority, Time-of-use Enable and 6 Time-of-use Slots. For more advanced mode Settings, see Section 10.

#### 7.3.2.2 System Setting/Page Two:

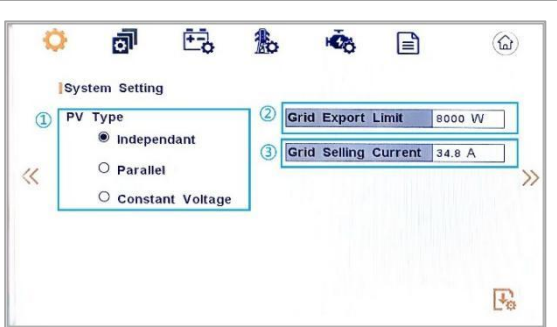

The screenshot shows the 'System Setting' interface on page two. It has a top navigation bar with icons for settings, system, inverter, battery, and a home button. The main content area is divided into two columns. The left column contains: 1. 'PV Type' with radio buttons for 'Independent', 'Parallel', and 'Constant Voltage'. The right column contains: 2. 'Grid Export Limit' with a text input field showing '8000 W'. 3. 'Grid Selling Current' with a text input field showing '34.8 A'. A confirm icon is at the bottom right.

② The default parameter is 8KW, allowing you to set the power the inverter sells to the grid. (It only works if the battery is present.)  
Grid Export limit , Grid Selling Current , Compare the two parameters and take the minimum value to take effect.

③ The default parameter is 34.8A, which can be set for the inverter to sell current to the power grid. (It only works if the battery is present.).

① Users can set PV types, including Independent, Parallel and Constant Voltage.

#### 7.3.2.3 System Setting/Page Three:

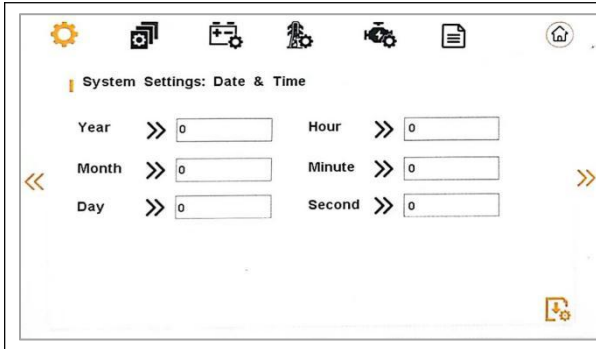

**Date and Time settings**  
 Users can manually modify the year, month, day, hour, minute and second.  
 The year input range should be between 2000 and 2099.

**7.3.2.4 System Setting/Page Four:**

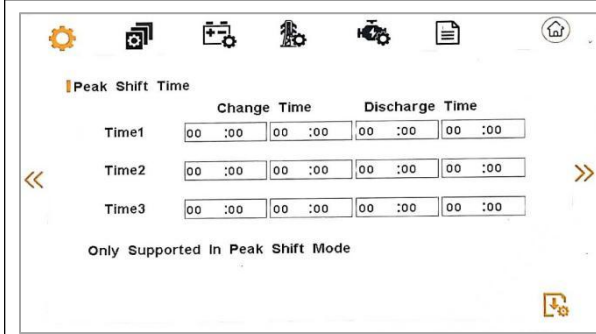

**Setting of charging and discharging time for Peak Shift.**  
 When the working mode is Peak Shift, users need to enter this interface to set the charging and discharging time. And Users need to manually input the start charge/discharge time and the end charge/discharge time.

**WORKTIME\***

1) The maximum allowable setting time is 24 hour (one day), It is allowed to set six different charging and discharging states within 24 hour(time1 twice,time2 twice,time3 twice), The inverter runs repeatedly every day according to the set time.

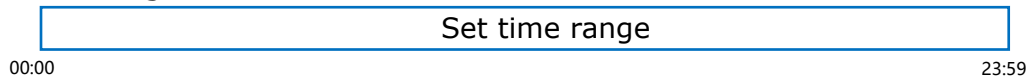

2) The inverter executes according to the settings of time1, time2 and time3 in the order of time. The following figure is an example. Different time periods do not overlap.

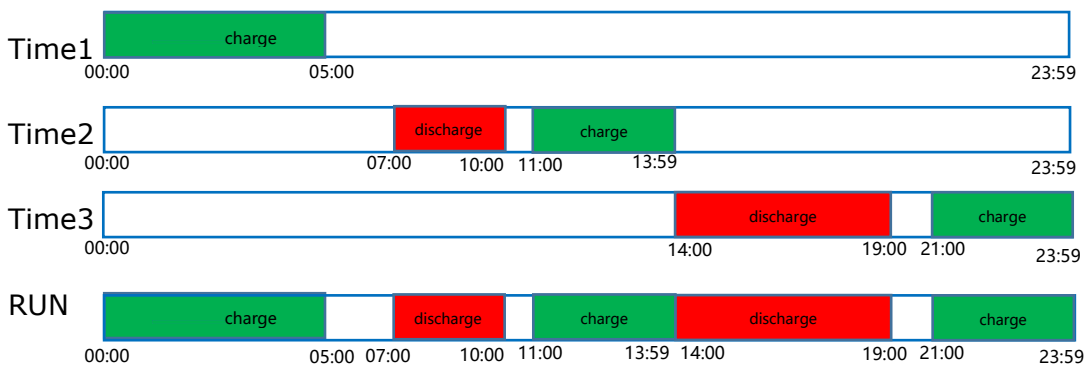

3) If you want to set a continuous charging time from the first night to the next morning. For example, you want to charge the battery from the first day 21:00pm to the next day 5:00am, divide this time period into two time periods (21:00~23:59, 00:00~05:00), and select two charging time periods from Time1, Time2 and Time3 and set them.

### 7.3.3 Parallel Settings

① **Parallel enable:** Start or disable the parallel function.  
**Master/Slave:** This interface is used for parallel, and the inverter is selected as the master or slave.

② **Common Grid CT:** Enable or disable CT sharing.

③ **3 Phase Parallel:** Enable or disable group 3 phase enable.  
**PHASE A/B/C:** This interface is used to select the output phase of the device when three phases are used.

④ **Parallel num:** This operation is used to select the number of parallel Inverters.  
**Parallel addr:** This interface is used to select the parallel address, the host address is set to 1 by default, if there is a slave, the slave is set to 2; If there are two slaves, the slaves are set to 2 and 3 respectively; the address settings of each inverter cannot be the same.  
**CT Ratio:** Set the CT ratio to 2000:1 by default.  
**Charge Curr:** This interface is used to select the parallel charging current.  
**Discharge Cur:** This interface is used to select the parallel discharge current.

### 7.3.4 Battery Settings

#### 7.3.4.1 Battery Type and Communications:

① Set Battery Type and Battery Communication method. Users can choose the **battery type** is lead-acid battery/lithium battery, and the **battery communication** method is CAN/RS485. The default option is CAN.

② Users can manually input the value of charging current and discharge power limit.

③ **Battery wake-up :** When the battery is low and the battery relay has been disconnected, the inverter will send instructions to the battery forcibly sucking relay by BMS, and the inverter will charge. The default option is disabled. (Partial battery support)



If you want to use this function, please consult the battery brand supported by the dealer. Use it only when the battery is too low.

After the battery wakes up successfully, please turn off the function, otherwise it will affect the normal operation of the Inverter.

④ **CAN ID**: The default is 0, and this function is only used for lithium batteries with specific communication protocols. If required, please contact the supplier.

### 7.3.4.2 Battery Setting:

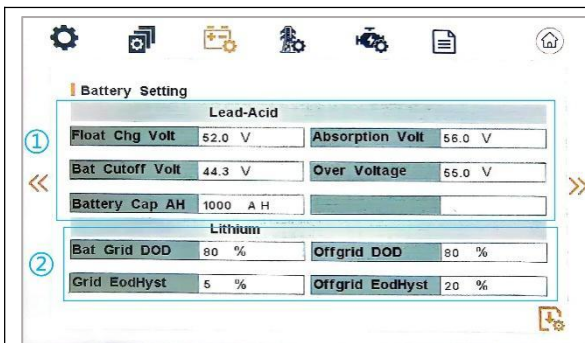

① Settings required when using lead-acid batteries

**Float Chg Volt:** Charge the battery with constant voltage and small current (This interface is used to set the lead acid battery charging voltage. (The input value ranges from 47V~59V) Set the floating charge voltage to be less than the constant charge voltage).

**Bat Cutoff Volt:** Discharge protection voltage (This interface is used to set the lead acid battery discharging voltage. (The input value ranges from 40 to 51) Discharge cut-off voltage, as recommended by the battery manufacturer).

**Battery Cap AH:** Battery capacity (This interface is used to set the lead acid Battery capacity. It is related to the input power. (The input value ranges from 50 to 1000) The battery capacity setting will affect the maximum charging current, for example, set 100Ah, the maximum

charging current is  $100A \times 0.2 = 20A$ ).

**Absorption Volt:** Charge the battery with constant current.

**Over Voltage:** Charging protection voltage (This interface is used to set the lead acid battery Charge protection voltage. (The input value ranges from 50 to 59.5) Charge protection voltage, as recommended by the battery manufacturer).

② Settings required when using lithium

**Bat Grid DOD/ Off-grid DOD:** When the battery discharge is higher than the set parameter, the inverter generates a battery low voltage alarm. Distinguish between grid-connected alarm parameters and off-grid alarm parameters.

**Grid Eod Hyst /Off-grid Eod Hyst:** When a low-voltage alarm is generated, the alarm is cleared if the battery charge is higher than the specified amount. The default minimum is 5% End Hyst.

## 7.3.5 Grid Setting

### 7.3.5.1 Grid Setting/Page one

① **Grid Settings:** Inverter default option is 120/240V Split Phase,

② **American Standard Classification:** Effective only when the grid Standard is America, American Standard Classification for multiple regions of America is provided.

### 7.3.5.2 Grid Setting/Page Two

This interface is used to select Grid standard. Users can set and switch grid standards according to their needs.

**Custom50Hz/60Hz:** Customize grid Settings.

### 7.3.6 Generator Setting

**Stop SOC:** When the SOC of battery is higher than the set point, the Generator dry contact is enabled and Generator Manual operation is disabled, the connected Generator will be stopped (START SOC < STOP SOC).

**Charge Current:** It indicates the maximum current that the inverter charges the battery from Generator.

**Gen Power:** Rated power of Generator.

**Cooling Time:** It indicates the waiting time of the Generator to restart after it has reached the running time. The unit is 0.1 hour.

**Max Operating:** It indicates the longest time Generator can run in one day, when time is up, the

① Diesel generator enable settings:

**Gen Enable:** Enable control of the Generator function.

**Gen Charge Enable:** Generator Charge Enable control.

**Gen Auto Start/Stop:** If the user wants the Generator to be automatically controlled to start and stop through the dry contact, please enable it.

**Gen Manual Start/Stop:** The on/off command in manual control mode.

**Gen Connect to Grid:** Connect the diesel Generator to the grid input port.

② Diesel generator parameter setting:

<p><b>Start SOC:</b> When the SOC of battery is lower than the set point, the Generator dry contact is enabled and Generator Manual operation is disabled, the connected Generator will be started.</p>	<p>Generator will be turned off. The value 240 means 24hours in which state the Generator will not be shut down all the time. The unit is 0.1 hour.</p>
---	---

## 7.3.7 Inverter Information

### 7.3.7.1 Inverter Information/Page One

	<ul style="list-style-type: none"> <li>① Show inverter module.</li> <li>② Energy storage inverter serial number.</li> <li>③ Show Inverter Software version.</li> <li>④ Display firmware version.</li> </ul>
--	---

### 7.3.7.2 Inverter Information/Page Two

	<p>you can use the following options to control the screen backlight. If the option does not enable, the screen will turn off in 3 minutes by default.</p> <ul style="list-style-type: none"> <li>② Screen backlight brightness adjustment. The value ranges from 0 to 100%.</li> <li>③ Set the screen-off time, value ranges from 5 to 250S.</li> </ul>
<p>① Screen backlight adjustment control,</p>	

### 7.3.7.3 Inverter Information/Page Three

	<p>This interface is used to reset the inverter.</p>
--	--

## 7.4 Maintenance Setting

### 7.4.1 Enter Maintenance Setting

#### 7.4.1.1 Input password

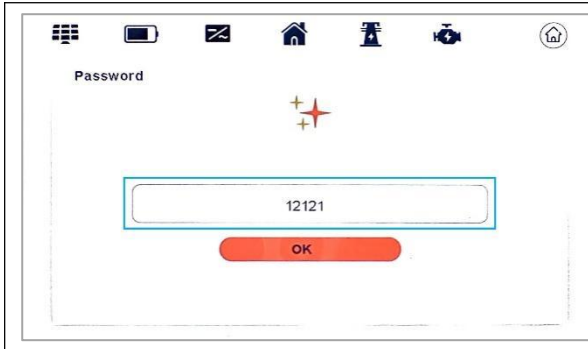

To enter the Maintenance settings, a password is required. The default password is 12121. Click OK to enter the settings interface.

**Note!**

Under normal circumstances, customers are not allowed to modify this interface parameters, if necessary, please contact the dealer.

**7.4.2 System settings**

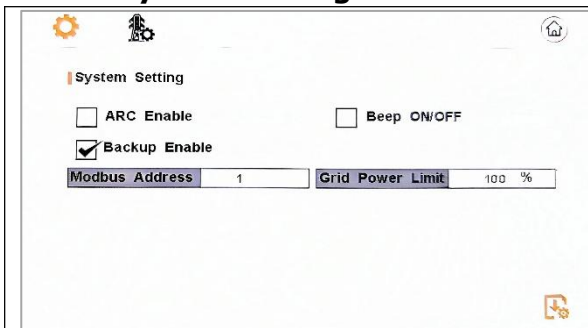

**Backup Enable:** When the Grid and PV are powered off, Enable the battery to supply power to the load, default option is enabled.

**Modbus Address:** The default value is 1 and you do not need to change it.

**Grid Export Limit:** Users can click to enter the numerical input interface. This function is used to limit the inverter conversion power of the inverter. The default parameter is 100%.

**ARC Enable:** ARC detection function.

**Beep ON/OFF:** Screen alarm switch. Set enabled, the buzzer will sound when the inverter alarms.

**7.4.3 Custom Grid Set**

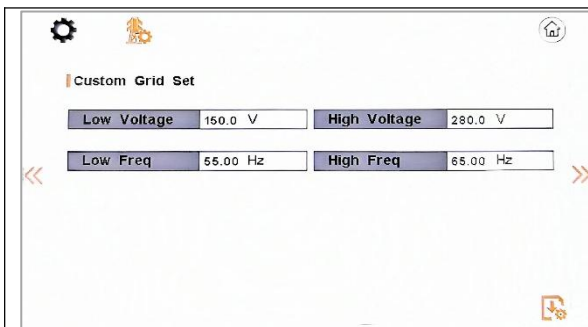

**Low Voltage:** The input value of Grid low voltage.

**High Voltage:** The input value of Grid high voltage.

**Low Freq:** The input value of Grid low frequency.

**High Freq:** The input value of Grid high voltage.

This parameter takes effect only when the power grid standard is custom.

### 7.4.4 Grid parameters

Grid parameters			
Vac HV1 Trip	264.0 V	Vac HV1 ClrTime	13.00 S
Vac HV2 Trip	288.0 V	Vac HV2 ClrTime	0.10 S
Vac HV3 Trip	312.0 V	Vac HV3 ClrTime	0.10 S
Vac LV1 Trip	211.2 V	Vac LV1 ClrTime	20.00 S
Vac LV2 Trip	192.0 V	Vac LV2 ClrTime	2.00 S
Vac LV3 Trip	120.0 V	Vac LV3 ClrTime	0.10 S

Grid parameters			
Fac HF1 Trip	61.20 Hz	Fac HF1 ClrTime	300.00 S
Fac HF2 Trip	62.00 Hz	Fac HF2 ClrTime	0.10 S
Fac HF3 Trip	67.00 Hz	Fac HF3 ClrTime	0.16 S
Fac LF1 Trip	59.50 Hz	Fac LF1 ClrTime	300.00 S
Fac LF2 Trip	56.50 Hz	Fac LF2 ClrTime	0.10 S
Fac LF3 Trip	45.00 Hz	Fac LF3 ClrTime	3.00 S

**Grid Protect parameters:**  
 This parameter is determined by the national grid standard. If the user needs to use over-voltage and under-voltage protection, please contact the supplier.  
 HV means high voltage trip protection.  
 LV means low voltage trip protection.  
 HF means high frequency trip protection.  
 LF means low frequency trip protection.

### 7.4.5 Grid Reconnect Parameter

Grid Reconnect Parameter			
Grid Volt Low	204.0 V	Grid Volt High	264.0 V
Grid Freq Low	57.00 Hz	Grid Freq High	60.50 Hz
Grid Reconnection Time	300.00 S		

**Grid Reconnection Parameter:**  
**Grid Volt Low/High:** Set the upper and lower limits of power grid voltage reconnect parameters.  
**Grid Freq Low/High:** Set the upper and lower limits of power grid frequency reconnect parameters.  
**Grid Reconnection Time:** The grid connection time can be set, but the minimum time cannot exceed 30S.

### 7.4.5 Grid Function

Grid Function	
<input type="radio"/> Discharge P(u)	<input checked="" type="radio"/> Anti Island
<input type="radio"/> Discharge P(f)	<input checked="" type="radio"/> Leak Current
<input type="radio"/> Charge P(u)	<input checked="" type="radio"/> Insulation Detection
<input type="radio"/> Charge P(f)	<input type="radio"/> LVRT
<input type="radio"/> HVRT	

**HVRT/ LVRT ( High/ Low Voltage Ride Through) :**  
 Enable the high/low voltage ride through function of the inverter.  
**Anti-Island:** When the grid goes down, inverter will detect the loss of power and disconnect from the grid within milliseconds. It prevents your solar panels from feeding electricity into a downed power line. (The

**Discharge P(U):** Generation voltage response.

<p>When the grid voltage is abnormal, the active power is limited, and the function is enabled when required by the national grid standard.</p> <p><b>Discharge P(f):</b> Generation frequency response.</p> <p>When the power grid frequency is abnormal, the active power will be limited, and the function will be enabled if required by the national power grid standard.</p> <p><b>Charge P(U):</b> Charge voltage response.</p> <p>When the grid voltage is abnormal, the charging power will be limited, and the function will be enabled if required by the national grid standards.</p> <p><b>Charge P(f):</b> Charge frequency response.</p> <p>When the power grid frequency is abnormal, the charging power will be limited, and the function will be enabled if required by the national power grid standard.</p>	<p>default option is enabled)</p> <p><b>Leak Current:</b> Leak current detect (The default option is enabled.)</p> <p><b>Insulation detection:</b> Insulation detect (The default option is enabled).</p> <p>When the insulation detection function is enabled in the grid connected state, the insulation detection is performed once a day when the photovoltaic energy comes in, and the inverter switches to the By-pass band load. If the inverter is off-grid, the output will be disconnected during insulation detect and the load will stop working.</p>
---	---

#### 7.4.6 Reactive Power Parameter

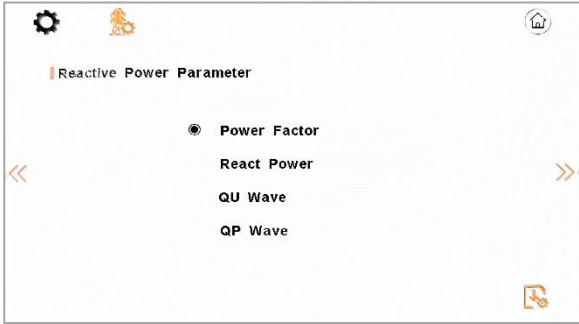
 <p><b>REACT Power Parameter:</b> REACT Power Parameter , including: <b>Power Factor, React Power, QU Wave, QP Wave.</b> (For specific country if required by the local grid.)</p>	<p><b>Power Factor:</b> The input value should range between L0.80 and L0.99 or C0.8 and C1.00.</p> <p><b>React Power:</b> Reactive power control</p> <p>The input value should range between -60% and +60%, which varies with the standard.</p> <p><b>QU Wave:</b> Voltage-reactive curve.</p> <p><b>QP Wave:</b> Active power-reactive power curve. (These two functions are not available on the screen, please contact the distributor if you need to use them.)</p>
---	--

## 8. Generator Use Operation Guide

### 8.1 Generator Use Diagram

The generator provides two wiring methods for connection, and the customer can choose one of them according to the actual situation.

1) The Generator is connected to the grid port of the inverter. The connecting cable shall be covered with CT. It is used in some off grid situations. The system diagram is as follows.

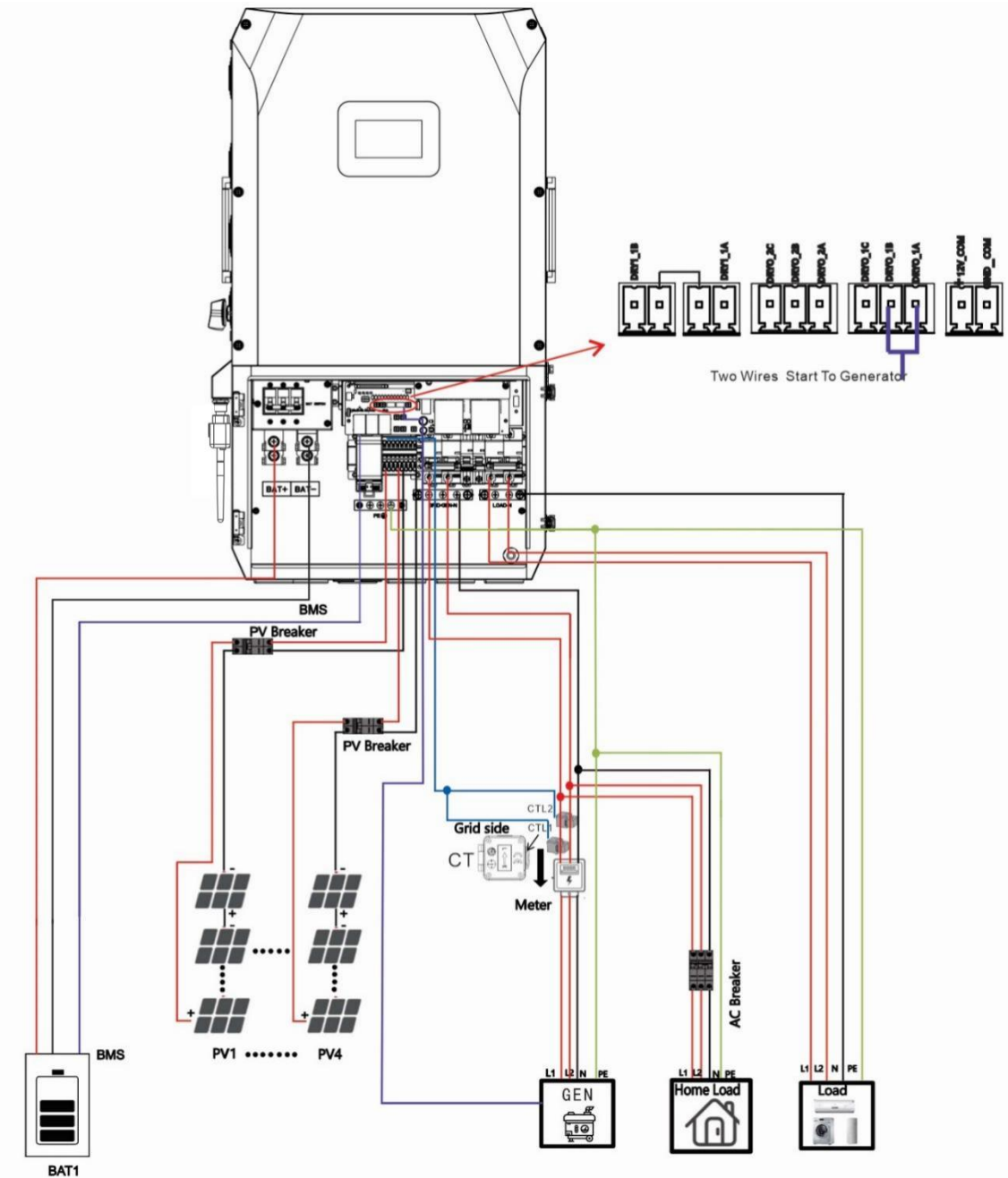

2) The Generator is normally connected to the Generator port. The connecting cable between the Generator and the inverter does not need to be covered with CT. The connection line of the power grid port should be connected with CT. The system diagram is as follows.

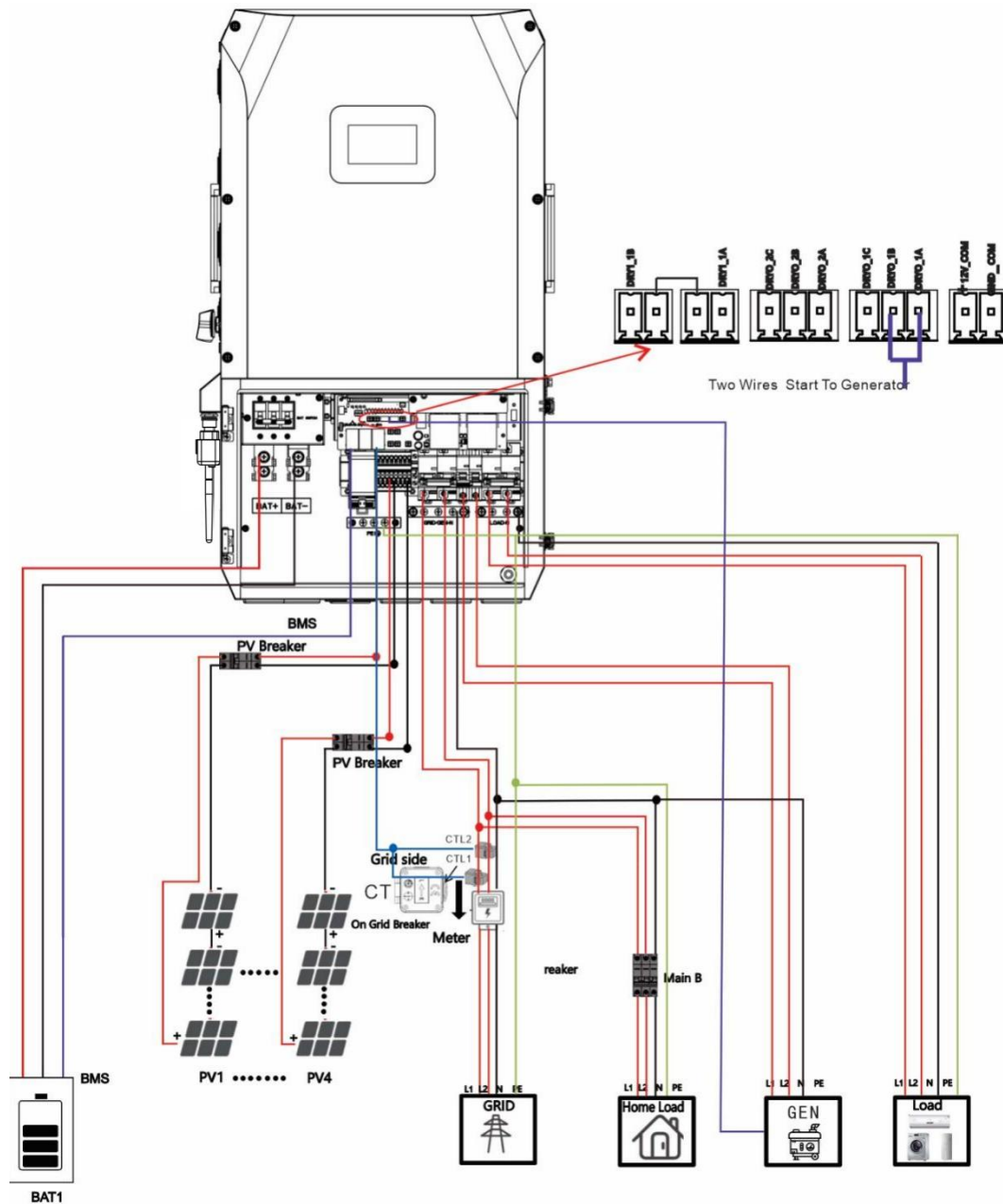

## 8.2 Generator Operation Notes

- 1) The two wires start signal **DRYO\_1A** and **DRYO\_1B** of the Generator is used to automatically control the start and stop of the Generator.
- 2) When the generator is used in inverter parallel situation, the two wires start signal is only needed to be connected to the master unit. The wiring and the setting of the Generator should be exactly same.



3) Please check the diagram above.

4) **The generator provides two modes (automatic and manual) for control, please select one mode to use, do not set both at the same time.**

5) **The input voltage and frequency of the generator are controlled by the protection parameters of this page.**

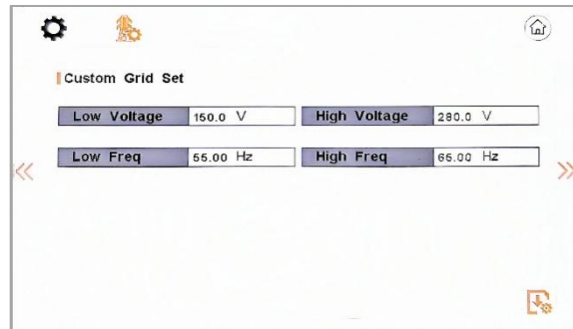

## 8.3 Generator Setting

### 8.3.1 Generator Setting (Lithium battery)

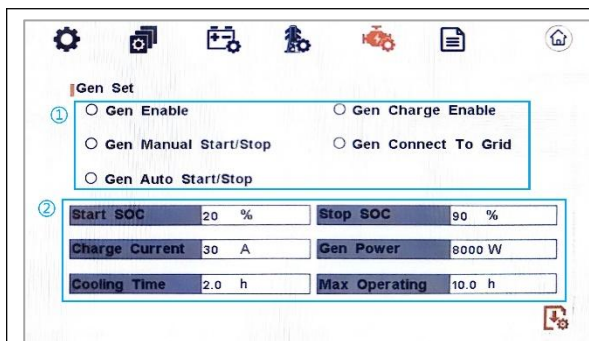

① Diesel generator enable settings:

**Gen Enable:** Enable control of the Generator function.

**Gen Charge Enable:** Generator Charge Enable control.

**Gen Auto Start/Stop:** If the user wants the Generator to be automatically controlled to start and stop through the dry contact, please enable it.

**Gen Manual Start/Stop:**

The on/off command in manual control mode.

**Gen Connect to Grid:** Connect the diesel Generator to the grid input port.

② Diesel generator parameter setting:

**Start SOC:** Generator in automatic

**Stop SOC:** Generator in automatic mode. When the SOC of battery is higher than the set point, the Generator dry contact is disconnected, the connected Generator will be stopped (START SOC < STOP SOC).

**Charge Current:** It indicates the maximum current that the inverter charges the battery from Generator.

**Gen Power:** Rated power of Generator.

**Cooling Time:** It indicates the waiting time of the Generator to restart after it has reached the running time. The unit is 0.1 hour.

**Max Operating:** It indicates the longest time Generator can run in one day, when time is up, the Generator will be turned off. The value 240 means 24 hours in which

<p>mode. When the SOC of battery is lower than the setpoint, the Generator dry contact is turn-on and the connected Generator will be started.</p>	<p>state the Generator will not be shut down all the time. The unit is 0.1 hour.</p>
--	--

### 8.3.2 Generator Setting (Lead-acid battery)

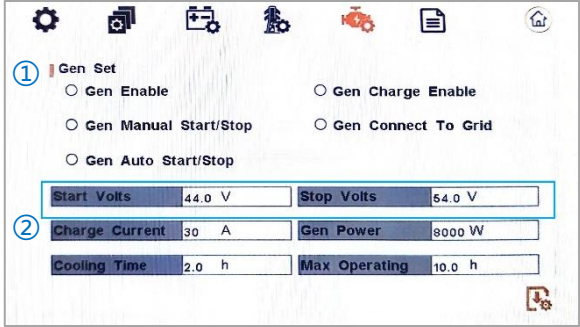
 <p><b>Start Volt:</b> Generator in automatic mode. When the volt of battery is lower than the setpoint, the Generator dry</p>	<p>contact is turn-on and the connected Generator will be started.</p> <p><b>Stop Volt:</b> Generator in automatic mode. When the volt of battery is higher than the set point, the Generator dry contact is disconnected, the connected Generator will be stopped (START Volt &lt; STOP Volt).</p>
---	---

### 8.3.3 Generator Automatic mode Setting

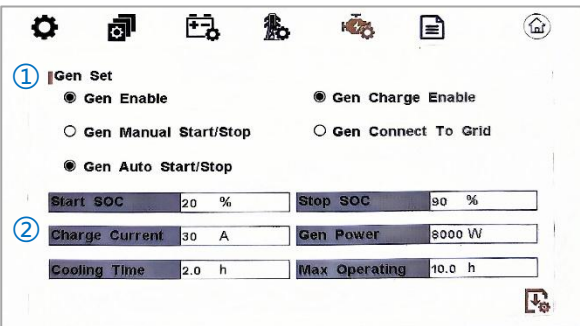
	<p>As shown in the picture on the left, select Gen Enable, Gen auto and Gen charge enable. Set generator on, off SOC or voltage, charging current, generator power, stop cooling time, maximum running time.</p> <p>If use the first connection mode, select Gen Connect To Grid.</p>
---	---

### 8.3.4 Generator Manual mode Setting

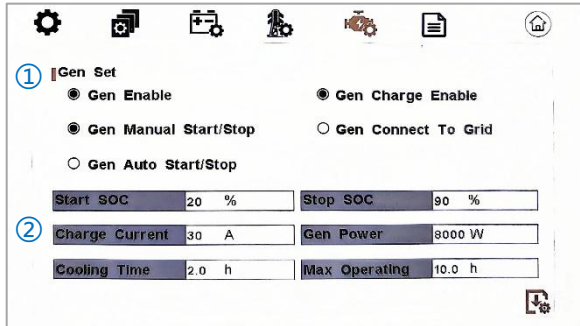
	<p>As shown in the picture on the left, select Gen Enable, Gen Manual and Gen charge enable. charging current, generator power, stop cooling time, maximum running time.</p>
---	--

# 9. Inverter Parallel Guide

## 9.1 Parallel System Diagram

### 9.1.1 Split phase (120/240Vac) parallell connection diagram.

GRID standard:US  
GRID Set:120V/240V

Parallel Set:  
Master Set:  
parallel num:3 parallel adr:1  
Master/slave: Master Common CT: Yes  
Parallel En:Enable  
Charge Curr: xxA Discharge Curr: xxA

Slave 1 Set:  
parallel num:3 parallel adr:2  
Master/slave: Slave Common CT: Yes  
Parallel En:Enable

Slave 2 Set:  
parallel num:3 parallel adr:3  
Master/slave: Slave Common CT: Yes  
Parallel En:Enable

GEN Set:  
Start SOC: xx% Stop SOC:xx%  
Charge Curr:xx A MAX run time:xx hour  
Cooldown:xx hour

Manual Contrl:  
GEN En enable Gen charge enable  
Auto Start: disable Manual start :enable  
Connect to Grid:disable

Auto Contrl:  
GEN En enable Gen charge enable  
Auto Start: enable Manual start :disable  
Connect to Grid:disable

Note:Set the master and slave at same time

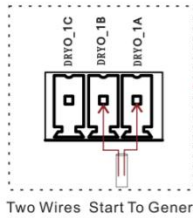

Two Wires Start To Generator

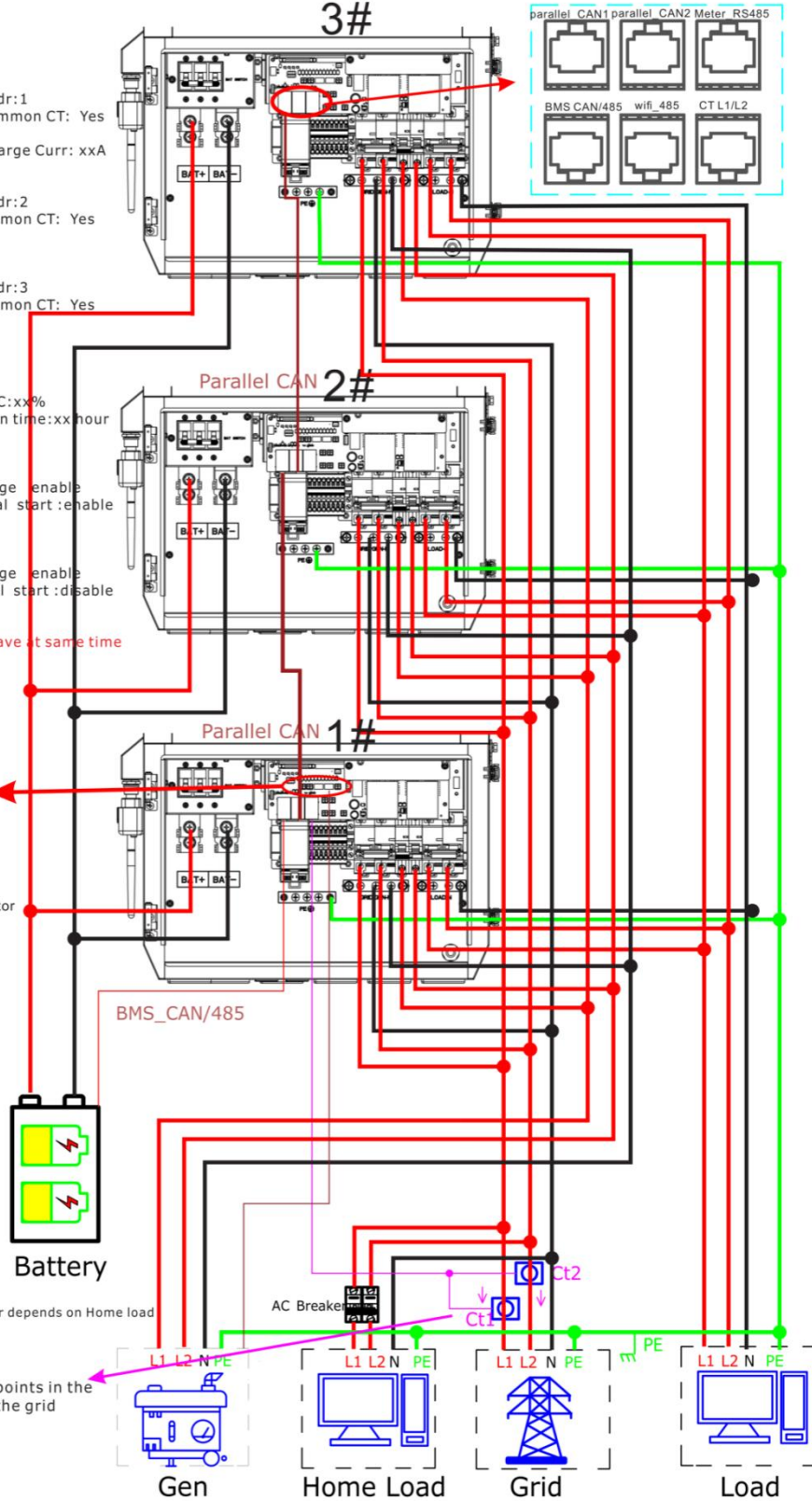

The CT arrow points in the directions of the grid

AC Breaker depends on Home load current.

### 9.1.2 Parallell connection for 120/208 three phase (American standard) .

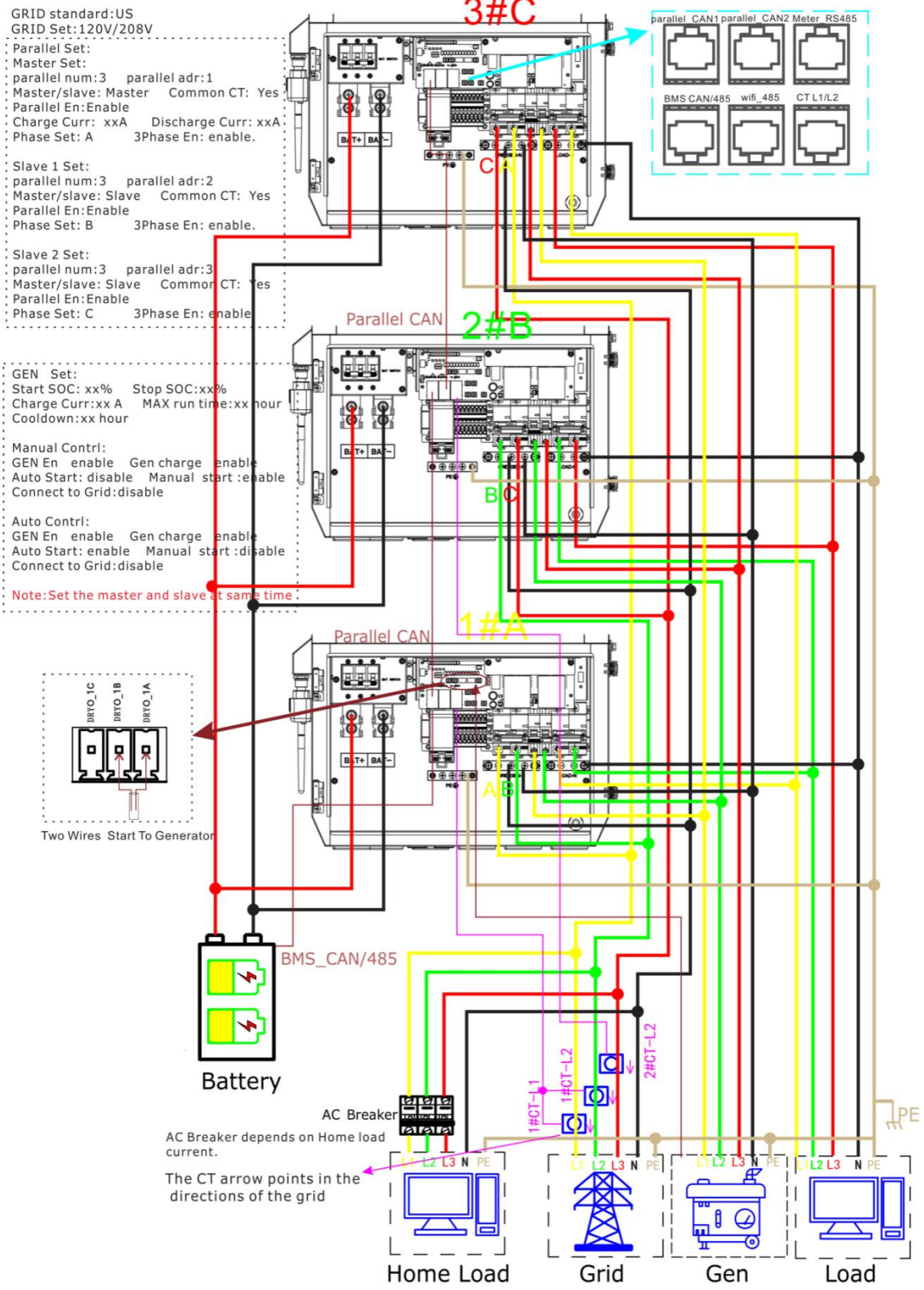

Multiple inverters can be installed together to deliver more power. When AC loads are present, all units effectively share the load. The system diagram is as follows.

When using the parallel Inverter, the user can choose to share CT or not share CT (without sharing CT, each inverter should be connected to one CT, CT connection method is the same as the single Inverter connection method). To use external loads, users must select the COMMON CT wiring method (as shown below) and select COMMON CT ENABLE.

**The inverter uses the battery parallel connection mode by default.** When using multiple batteries, please refer to the battery manual to correctly connect to the inverter, and connect the battery communication line to the master.

## 9.2 Parallel Communication Cable Connection

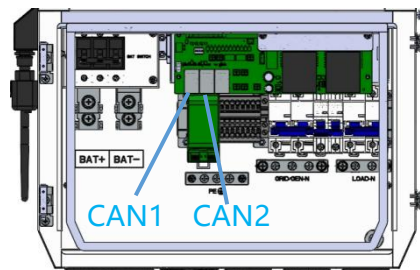

For parallel communication, CAT 5 cables are needed. The units should be connected hand by hand.

When using common batteries, BMS cable needs to be connected to the master unit. The inverter shares the BMS information by inter-unit parallel communication cable.

## 9.3 Parallel Operation Notes

1) Make sure all the units in parallel are with the same software version.

**Password->Information**

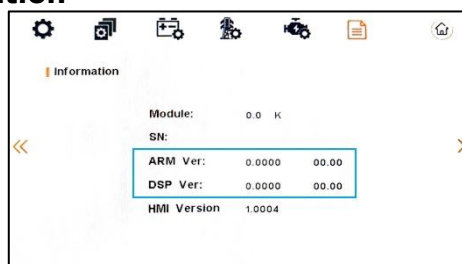

2) Please check the diagram above. The common batteries use is supported on default for maximizing the system efficiency. The BMS cable should be connected to the master inverter.

3) Connect the loads of the two inverters together first. It should be noted that **the grid power line and the load line of the two inverters should be roughly the same length.**

4) Make sure the CT Limiter sensor is installed properly. If the load is connected outside the inverter, user need to choose common CT and make sure the CT ratio is right (the default 200A CT ratio is 2000:1, no need to change). The common CT is only needed to be connected to the master inverter. Please install CT on every unit's incoming electrical service wire on L1 and L2 when choosing independent CT.

5) Please check the master and slaver's setting by screen and make sure all the setting are correct.

**6) When the parallel system is connected to the generator function, each inverter needs to be connected to the generator.**

## 9.4 Parallel System Setting

The parallel setting page can be visited in the following steps in the screen:

**Password->Parallel Settings**

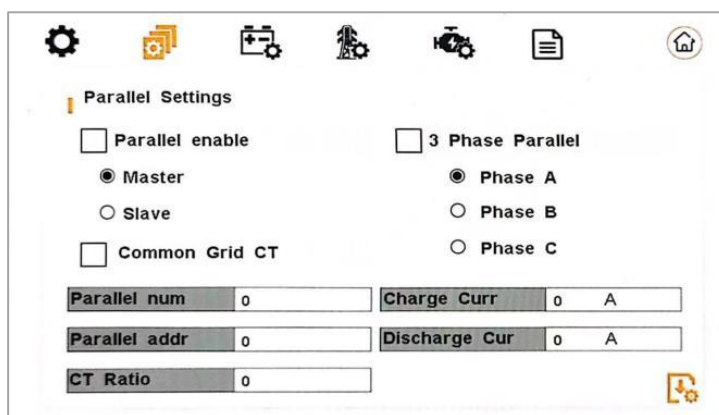

### 9.4.1 Parallel Settings

	<p>① <b>Parallel enable:</b> Start or disable the parallel function.</p> <p><b>Master/Slave:</b> This interface is used for parallel, and the inverter is selected as the master or slave.</p> <p>② <b>Common Grid CT:</b> Enable or disable CT sharing.</p>
<p>③ <b>3 Phase Parallel:</b> Enable or disable group 3 phase enable.</p> <p><b>PHASE A/B/C:</b> This interface is used to select the output phase of the device when three phases are used.</p> <p>④ <b>Parallel num:</b> This operation is used to select the number of parallel Inverters.</p> <p><b>Parallel addr:</b> This interface is used to select the parallel address, the host address is set to 1 by default, there is a slave, and the slave is set to 2; If there are two slaves, the slaves are set to 2 and 3 respectively;</p>	

the address settings of each inverter cannot be the same.

**CT Ratio:** Set the CT ratio to 2000:1 by default.

**Charge Curr:** Set the total battery charging current of multiple parallel inverters, and the current will be evenly distributed to each inverter. Parameters are set only by the master.

**Discharge Cur:** Set the total battery discharge current of multiple parallel inverters, and the current will be evenly distributed to each inverter. Parameters are set only by the master.



**Note!**

- If you need to assemble the split phase into three phases, please make the following settings:  
1. 3PHASE EN; 2. PARALLEL EN; 3. PHASE Selection; 4. Grid Standard (United States); 5. Power Grid Settings (US 208V); 6. Master/slave selection; 7. Number of parallel machines; 8. ADDRESS.

## 10. Advanced Mode Operation Guide

### 10.1 Advanced Mode Introduction

The hybrid inverter can be programmed to control how and when to use grid power. The Advanced mode allow management of flexible loads and time-of-use billing.

There are three advanced mode available: **Sell First Mode**, **Limited Consumption Mode** and **Zero export Mode**.

Advanced Work Mode			
	Selling First	Limited Consumption	Zero export
grid sell Disable/Enable	Ignored. Be enabled automatically	For those region with feed-in-tarriff, plz enabled it.	Ignored. Be disabled automatically
Mode Description	<p><b>Features:</b> Bat storage power can be sold out to power under TOU control.</p> <p><b>When TOU is enabled:</b> When inside time slots: Charge or Discharge to grid at scheduled time and specific power without caring consumption.</p> <p>When outside of the time slots: The grid can not charge the battery, only allow the PV to charge the battery.</p> <p><b>When TOU is disabled:</b> Always charge the battery first whatever from pv or grid. The battery doesn't discharge on grid mode.</p>	<p><b>Features:</b> Use some grid power first, then use battery storage power under TOU control.</p> <p><b>When TOU is enabled:</b> <b>Day time:</b> PV power load and charge battery first, surplus power feedback to grid( grid sell enable) or limit the pv yield(grid sell disable). <b>The grid charge can be scheduled.</b></p> <p>When outside of the time slots: The grid can not charge the battery, only allow the PV to charge the battery.</p> <p><b>When TOU is enabled:</b> <b>Night time:</b> discharge battery to power the load if the battery capacity is available. For those region with tiered electricity price, user can set ct limit power to use some grid power first. <b>The grid charge can be scheduled.</b></p> <p><b>When TOU is disabled:</b> Always charge the battery first whatever from pv or grid. The battery doesn't discharge on grid mode.</p>	<p><b>Features:</b> Never sell power to grid forever.</p> <p><b>When TOU is enabled:</b> <b>Day time:</b> PV power load and charge battery first, <b>surplus power will be limited</b> automatically. <b>The grid charge can be scheduled.</b></p> <p>When outside of the time slots: The grid can not charge the battery, only allow the PV to charge the battery.</p> <p><b>When TOU is enabled:</b> <b>Night time:</b> discharge battery to power the load if the battery capacity is available. <b>The grid charge can be scheduled.</b></p> <p><b>When TOU is disabled:</b> Always charge the battery first whatever from pv or grid. The battery doesn't discharge on grid mode.</p>

There are also some attributes of these mode: **Global Grid Charge Enable**, **PV Charge Only**, **Battery First**, **Time-of-use Enable** and **6 Time-of-use Slots**. The time slots parameters are shown in as below:



Start Time	End Time	Bat Power	Grid Charge	Bat SOC
00:00	05:00	8000 W	√	50 %
05:00	08:00	8000 W		50 %
08:00	10:00	8000 W	√	50 %
10:00	16:00	8000 W		50 %
16:00	19:00	8000 W	√	50 %
19:00	23:59	8000 W	√	50 %

### 10.1.1 Advanced Mode Setting:

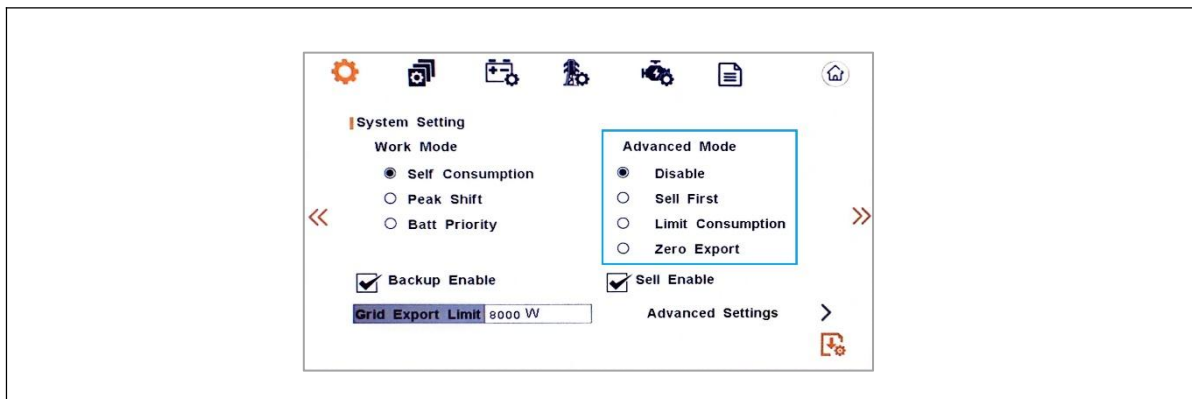

#### Advanced mode:

There are four options here: Disable, Sell First Mode, Limited Consumption Mode and Zero Export Mode.

**Disable:** Only when users selected "Disable", the three work modes (Self Consumption, Peak Shift, battery priority) take effect. When the user selects the other three options, the three working modes (Sell First, Limit Consumption, Zero Export) are invalid.

**Sell First:** First consider selling electricity to the grid. In this mode the Sell-Enable setting is automatically enabled. The users can use this mode to sell back surplus solar power to grid. If time of use is enabled, the battery power can also be sold to grid (Excess PV and battery power can be sold to the grid) .

**Limit Consumption:** In this mode, the CT limiters are used to sense the grid power flow direction. The hybrid inverter can be select to sell power or not sell power to grid. There is a CT Limit Power parameter available in this mode. When the battery is needed to discharge to reduce the load consumption, the grid will cover the parameter set part consumption firstly and the battery discharges energy to makes up the rest part. Other conditions are similar to SELF CONSUME working mode (Excess PV power can be sold to the grid through CT Limit.) .

**Zero Export:** In this mode, the CT limiters should be installed in the input of the inverter's grid port. The hybrid inverter will not sell power to grid. The user can use Zero export power parameter to ensure the inverter won't feedback power to grid (Neither PV nor battery excess power is sold to the grid) .

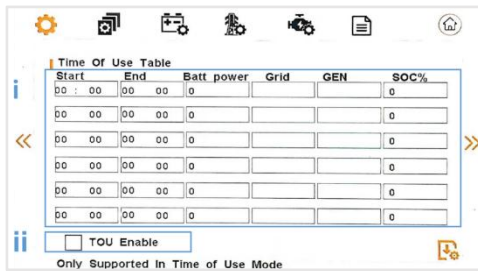

## ⑥ Advanced Settings

Users can click to **Advanced Settings** > enter the advanced settings interface.

There are also some attributes of these mode: Global Grid Charge Enable, PV Charge Only, Bat Charge on Priority, Time-of-use Enable and 6 Time-of-use Slots.

Advanced Settings/First Page:

**i Time-of-use Enable:** There are 6 slots which can be programmed. If grid charge is enabled, the grid is used to power the load and charge the battery to target SOC at specific bat power attribute value. If selling electricity to the grid enable, the battery will discharge to target SOC at specific battery power attribute value.

**Grid:** Grid is ticked, indicating that in the effective interval of the current interface time period, if the set SOC is greater than the actual SOC of the battery, the power grid will charge the battery (if not ticked, the power grid will not charge the battery); if the set SOC is less than the actual SOC of the battery, the battery can be discharged.

**GEN:** GEN is ticked to indicate charging with GEN.

**Batt power:** The power that the grid charges and discharges to the battery

**ii** Only when TOU Enable is selected, the time table in the figure can be effective.

Advanced Settings/Second Page:

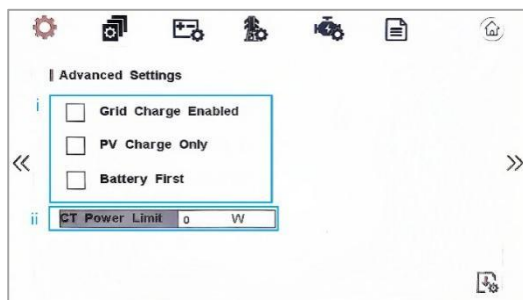

**i.** Users have three advanced settings to choose from, namely Global Grid Charge Enable, PV Charge Only and Battery First.

**Global Grid Charge Enable:** It is advanced control attribute of grid charge enable. If time of use function is disabled, this attribute is used to judge whether or

not to charge the battery by grid. If time of use function is enabled, the battery can be charged by grid only when the time slot grid charge attribute is enabled.

**PV Charge Only:** If user don't want to use grid to charge the battery in any time, please enable this attribute. The PV energy will be used first for the load, and then the excess energy will be used to charge the battery. If the PV energy is insufficient, the battery will power the load.

**Battery First:** If there will be a storm or other emergency, user can use this attribute to adjust the power distribution priority. If this attribute is disabled, the solar power will cover the load on priority by default.

**ii. CT Power Limit:** This function takes effect only in Limit Consumption mode and is used to draw power from the grid.

**Note!**

- If the use time is started and the inverter is operating outside the timeline, it will run in SELF CONSUME mode.
- Advanced mode only makes sense when both the battery and the grid exist.

## 11. Fault diagnosis and solutions

The inverter is easy to maintain. When you encounter the following problems, please refer to the Solutions below, and contact the local distributor if the problem remains unsolved. The following table lists some of the basic problems that may occur during the actual operation as well as their corresponding basic solutions.

### Fault diagnosis table

Content	Codes	Explanation	Solutions
DischgOverCur	01	Battery discharge over current. When the battery is loaded, the load is too large.	(1) Nothing needed to do, wait one minute for the inverter to restart. (2) Check whether the load is in compliance with the specification. (3) Cut off all the power and shut down all the Inverters; disconnect the load and plug in to restart Inverters, then check
Over Load	02	The load power is greater than other power. (PV, BAT)	(1) Check whether the load is in compliance with the maximum power of the Inverter. (2) Cut off all the power and shut down all the Inverters; disconnect the load and plug in to restart Inverters, then check whether the load is short circuited if the fault has been eliminated. (3) Contact customer service if error warning continues.
Bat Disconnect	03	Battery Disconnect. (Battery voltage not identified)	(1) Check whether the battery is connected. (2) Check if battery wiring port is open circuited. (3) Contact customer service if error warning continues.

Bat Under Vol	04	Battery voltage lower than normal range.	<ol style="list-style-type: none"> <li>(1) Checking System Settings, If so, power off and restart.</li> <li>(2) Check if the grid power down. If so, wait for grid to power up, the inverter will automatically charge.</li> <li>(3) Contact customer service if error warning continues.</li> </ol>
Bat Low capacity	05	Bat Low capacity	(1) Battery Lower than setting capacity. (SOC<100%-DOD)
Bat Over Vol	06	The battery voltage is greater than the Inverter maximum voltage.	<ol style="list-style-type: none"> <li>(1) Checking System Settings, If so, power off and restart.</li> <li>(2) Contact customer service if error warning continues.</li> </ol>
Grid low vol	07	Grid voltage is abnormal	<ol style="list-style-type: none"> <li>(1) Check if the grid is abnormal.</li> <li>(2) Restart the inverter and wait until it functions normally.</li> <li>(3) Contact customer service if error warning continues.</li> </ol>
Grid over vol	08		
Grid low Freq	09	Grid Frequency is abnormal.	<ol style="list-style-type: none"> <li>(1) Check if the grid is abnormal.</li> <li>(2) Restart the inverter and wait until it functions normally.</li> <li>(3) Contact customer service if error warning continues.</li> </ol>
Grid over Freq	10		
Gfci over	11	Inverter GFCI exceeds standard.	<ol style="list-style-type: none"> <li>(1) Check PV string for direct or indirect grounding phenomenon.</li> <li>(2) Check peripherals of Inverter for current leakage.</li> <li>(3) Contact the local inverter customer service if fault remains unremoved.</li> </ol>
bus under vol	14	BUS voltage is lower than normal.	<ol style="list-style-type: none"> <li>(1) Check the input mode setting is correct.</li> <li>(2) Restart the inverter and wait until it functions normally.</li> <li>(3) Contact customer service if error warning continues.</li> </ol>
bus over vol	15	BUS voltage is over maximum value.	<ol style="list-style-type: none"> <li>(1) Check the input mode setting is correct.</li> <li>(2) Restart the inverter and wait until it functions normally.</li> </ol>
Inv over cur	16	The inverter current exceeds the normal value.	(1) Restart the inverter and wait until it functions normally.
Chg over cur	17	Battery charge	(1) Restart the inverter and wait until it

		current over than the Inverter maximum voltage.	functions normally.
Meter Comm Fail	18	Meter Comm Fail	(1) Check whether the meter communication line is connected correctly.
Inv under vol	19	INV voltage is abnormal	(1) Check if the INV voltage is abnormal. (2) Restart the inverter and wait until it functions normally. (3) Contact customer service if error warning continues.
Inv over vol	20		
Inv Freq Abnor	21	INV frequency is abnormal	(1) Check if the INV frequency is abnormal. (2) Restart the inverter and wait until it functions normally. (3) Contact customer service if error warning continues.
Igbt temp high	22	The inverter temperature is higher than the allowed value	(1) Cut off all the power of the Inverter and wait one hour, then turn on the power of the Inverter.
bat over temp	23	Battery temperature is higher than the allowed value.	(1) Disconnect the battery and reconnect it after an hour.
bat Under Temp	25	Battery temperature is low than the allowed value.	(1) Check the ambient temperature near the battery to see if it meets the specifications.
Relay open circuit	26	Grid side relay open circuit detection	(1) Used to detect whether the relay on the power grid side is disconnected due to a fault.
BMS comm. fail	28	Communication between lithium battery and inverter is abnormal.	(1) Check the cable, crystal, Line sequence. (2) Checking the Battery switch.
Fan fail	29	Fan fail	(1) Check whether the Inverter temperature is abnormal. (2) Check whether the fan runs properly. ( If you can see it)

Grid Phase err	31	The grid fault phase.	(1) Check power grid wiring
Arc Fault	32	PV Arc Fault	(1) Check Photovoltaic panels, PV wire. (2) Contact customer service if error warning continues.
bus soft fail	33	Hardware may be damaged and need to troubleshoot the cause	(1) Restart the inverter and wait until it functions normally. (2) Contact customer service if error warning continues.
inv soft fail	34		
bus short	35		
inv short	36		
fan fault	37	Fan fault.	(1) Check whether the Inverter temperature is abnormal. (2) Check whether the fan runs properly. ( If you can see it)
PV iso low	38	PV iso low	(1) Check if the PE line is connected to the inverter and is connected to the ground. (2) Contact customer service if error warning continues.
Bus Relay Fault	39	The inverter may be damaged	(1) Restart the inverter and wait until it functions normally. (2) Contact customer service if error warning continues.
Grid Relay Fault	40		
EPS rly fault	41		
Gfci fault	42		
Selftest fail	45		
System fault	46		
Current DCover	47		
Voltage DCover	48		

Note: If an error occurs that is not listed in the table, Please Contact customer service.

## **NOTICE:**

The copy right of this manual belongs to Amensolar ESS Co., Ltd. Any corporation or individual should not plagiarize, copy, reduction, or distribution this manual in any form or by any means. All rights reserved.

The information in this document (including software, etc.) is subject to change without notice. Every effort has been made to ensure the accuracy of the contents during the preparation of this document, but all statements, information and suggestions in this document do not constitute any express or implied warranty in any form. Amensolar ESS Co., Ltd.reserves the right of final interpretation.

**Amensolar ESS Co., Ltd.**

Web: [www.amensolar.com](http://www.amensolar.com)

Add: No. 900, Zhujiang Road, SND, Suzhou City, Jiangsu Province, PRC

Tel: 0086-512-68243965